



BRINKLEY

— RV —

MODEL GX

OWNER'S MANUAL

DEAR BRINKLEY RV CUSTOMER,

Thank you for choosing Brinkley! Your satisfaction with your Brinkley RV and the entirety of your Customer Experience is of the utmost importance to us. We are here to help you along your RV'ing journey to ensure that your Brinkley RV facilitates the memories that you cherish for a lifetime. Your Brinkley RV is designed and manufactured to meet and exceed all applicable state and federal regulations, codes, and requirements—including the Recreational Vehicle Industry Association's (RVIA) codes and standards. We are committed to the safety of you and your family, keeping you on the road, and camping!

To help you get started along your journey, we supply every Brinkley RV with an Owner's Manual, Warranty Guide, and any manuals made available by the manufacturers of the various appliances and components installed in your RV. We ask that you please read these documents thoroughly, as it is very important that you and your family know how to properly use and maintain your RV, its components, systems, and appliances to ensure a safe camping experience.

You are also provided certain warranties as a benefit of your Brinkley RV Ownership. Those warranties are all included in the separate Warranty Guide provided to you with the purchase of your Brinkley RV. In addition to the owner's manuals, you should thoroughly read through the warranties provided. The Warranty Guide explains not only the provided, but it also includes: coverage validity dates, the extent of coverage, what exclusions or limitations of coverage apply, and how to seek and obtain warranty service and care. Please note that some ongoing maintenance is required to be performed at specified intervals to comply with the requirements of your warranties. Failing to perform required maintenance could result in a partial or complete loss of warranty coverage.

Brinkley RV and our exceptional Dealer Teams are committed to providing you with an amazing Customer Experience. If we are not exceeding your expectations, please do not hesitate to contact us. Our contact information is located at the bottom of each page of your manuals. We are here for you. Please share with us your feedback on how we can better serve you along your journey. We need your valuable input to evolve as a company and achieve our mission:

To provide you with the ultimate Customer Experience that creates the memories you will cherish for a lifetime!

Sincerely,

The Brinkley RV Team



MODEL Gx



BRINKLEY

RV

In our relentless pursuit of product improvement and the ultimate Customer experience, changes may take place at any time to our models. It is our goal to strive to keep this manual as up-to-date as possible. As changes occur, we will provide additional product information documents in the rear pocket of the Owner's Manual. We will also maintain digital versions on our website, www.BrinkleyRV.com. The QR codes below will take you to our site.

Should you have any questions, please do not hesitate to contact us.

We are here to serve you!

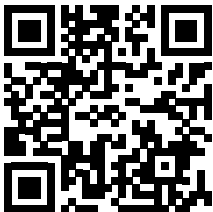

Brinkley Website



Model Gx Owner's Hub

Copyright © 2026, Brinkley RV. No part of this publication may be reproduced, distributed, or transmitted in any form or by any means, including photocopying, recording, or other electronic or mechanical methods, without the prior written permission of the publisher, except as permitted by U.S. copyright law.

Version: February 2026
Revision Date: 2/9/2026

CONTENTS

SEC.01 INTRODUCTION

A. About This Manual	8
B. Owner Information Package	9
C. Manufacturing Certifications	9
D. Vehicle Identification Number	10
E. Safety Precautions	11
F. Additional Terminology Used	11

SEC.02 REPORTING SAFETY DEFECTS

A. How To Report Safety Defects	12
---------------------------------	----

SEC.03 SERVICE & WARRANTY

A. Dealer's Responsibilities	13
B. Owner's (Your) Responsibilities	14
C. Obtaining Warranty Service	14
D. Emergency Warranty Repair	15
E. Replacement Parts	17
F. Aftermarket Installations or Alterations	17
G. Updating Your Contact Information	17

SEC.04 OCCUPANT SAFETY

A. Develop A Family Safety Plan	18
B. Emergency Weather Planning	19
1. General Information	19
2. Repairing Severe Weather Damage	19
C. Fire Safety	19
1. General Information	19
2. Fire Emergencies	19
3. Common and Important Fire Safety Information	20
4. Fire Extinguishers	21
a. General Information	21
b. Operation	21
c. Disposal	21
1. General Information	22
D. Emergency Egress Windows	22
1. General Information	22
2. Maintenance	22
E. Smoke Alarm	22
2. Testing a Smoke Alarm	23
3. Maintenance	24
F. Carbon Monoxide (CO)	24
1. General Information	24
2. Carbon Monoxide (CO) Alarm	25

a. General Information	25
b. Testing the CO Alarm	26
c. CO Alarm Maintenance	26
G. Propane (LP) Gas Alarm	27
1. General Information	27
H. Indoor Air Quality	28
1. Maintaining Indoor Air Quality	28
2. Improving Indoor Air Quality	28
3. EPA Recommendations	29
4. Chemical Sensitivity and Offgassing	29
a. General Information	29
b. Formaldehyde	30
c. California Air Resource Board Notice	30
5. Condensation and Moisture	30
a. General	30
b. Controlling Condensation	30
c. Hot Weather Conditions	31
6. If There Is Moisture, There May Be Mold	31
a. General	31
b. Mold Prevention	32
I. Cold Weather Use	32
J. Websites Of Interest	32
K. Additional Safety Precautions	33
1. Generators	33
2. Loading and Weight Distribution	33
3. Passenger Safety	34
4. Propane Appliances and Equipment	34
5. Tire Pressure	34
6. Towing	34
7. Wheel Torque	34

SEC.05 PRE-TRAVEL INFORMATION

A. General	35
B. Tow Vehicle Disclaimer	35
C. Vehicle Labels	35
1. Weight Ratings and Definitions	35
2. Weight Labels	37
3. Federal Certification Label	37
4. Tire and Loading Information Label	37
5. Cargo Carrying Capacity (CCC) Label	37
6. RV Length	38
a. Travel Trailers	38
b. Fifth Wheel Trailers	38
c. RV Overall Length Exclusions	38
D. Cargo Capacities And Weights	38

1. Maximum Load Rating	38	G. Towing The RV	58
2. Water and Propane (US ONLY)	39	1. Braking and Stopping Distance	58
3. Loading Your RV	39	2. Weight and Clearance Limits	59
4. Weighing the Tow Vehicle and RV	39	3. Road Conditions	59
a. In General	39	4. Turning Corners	59
b. Weighing Your Tow Vehicle and RV	40	5. Passing	59
E. Tire Safety Information	42	6. Backing-Up	59
1. Introduction	42	7. Parking	60
2. Maximum Load Rating	42	H. Unhitching From The Tow Vehicle	60
3. Maximum Inflation Pressure	42		
4. Tire Pressure and Load Limits	42		
5. Checking Tire Pressure	43		
a. Frequency	43		
6. Overloading Your RV and Tires	44		
7. Proper Tire Load Limits	45		
8. Tire Safety Tips	45		
9. Tire Labeling	45		
10. Tire Size and Type Designation	46		
F. Tire Tread	47		
G. Tire Ply Composition And Materials	48		
H. Spare Tire	48		
I. Tire Changing Basics	49		
J. Wheel Nut Torque	49		
K. Tire Warranty	50		
L. Roadside Emergency	50		
SEC.06 TIRE PRESSURE MONITORING SYSTEM			
A. General Information	51		
SEC.07 TOWING & HITCHING			
A. Recommended Safety	52		
B. RV Driving Schools and Seminars	52		
C. RV Braking System	53		
1. General	53		
2. Brake Controller	53		
3. Axles and Suspension Options	53		
E. Breakaway Switch	54		
F. Fifth Wheel Pin Box Hitch	55		
1. General Information	55		
2. Gooseneck Pin Box	56		
3. Fifth Wheel Pin Box Height	56		
4. Standard Pin Box Hitching	57		
5. Gooseneck Pin Box Hitching	58		
SEC.08 LEVELING			
A. Introduction	61		
B. Components	61		
C. Safety	61		
D. Prior To Operation	62		
E. System Operation	62		
1. Auto Level Instructions	62		
SEC.09 SLIDE-OUT SYSTEMS			
A. General Information	63		
B. Operation	63		
C. Slide-Out Maintenance	64		
D. Slide-Out Systems Used	64		
SEC.10 HAPPIJAC POWER BED LIFT SYSTEM			
A. General Information	65		
B. Safety Precautions	65		
C. Operation	65		
1. General Operation	65		
2. Stowing/Locking the Upper Bunk	66		
3. Un-Stowing/Releasing the Upper Bunk	67		

CONTENTS

SEC.11 ELECTRICAL SYSTEMS

A. General Information	68
B. Electrical System Maintenance	68
C. 50 Amp Power Cord	68
1. Shore Cord Power	69
2. Power Cord Maintenance	69
D. 120 Volt AC System	70
1. General Information	70
2. 120-Volt Circuit Breakers	70
3. Maintenance and Replacement	71
4. Converter	71
5. Inspection and Maintenance	71
6. GFCI Receptacle	71
E. 12 Volt DC System	72
1. 12-Volt DC USB Ports	72
2. 12-Volt Fuse Panel	72
3. Auxiliary Battery(ies)	73
4. Dry Camping	73
5. Maintaining/Replacing 12V Equipment	74
F. Battery Disconnect Switches	75
G. Calculating Electrical Load	75
1. General Information	75
2. Approximate Electrical Load Ratings	76
H. Replacing Light Bulbs	76
I. Solar Power	76
1. Solar Docking Port	77
2. Solar Power Charging System	77

SEC.12 GENERATOR

A. Introduction	78
1. Safety Precautions	78
2. Before Operating the Generator	78
3. Generator Control Panel Basics	79

SEC.13 FUEL STATION

A. Introduction	80
B. General Safety	80
C. Filling The Fuel Tanks	81
D. Dispensing Fuel	81

SEC.14 AUDIO, VIDEO, & CONNECTIVITY

A. Introduction	83
B. Audio—Rockford Fosgate© Sound System	83
1. Wired Remotes - Punch PMX-1R	83
2. Location of the Punch PMX-1R Remote	83
3. PMX-1R Remote—Features	83
4. Basic Operation of the Sound System	84
C. Audio/Visual Systems	84
1. TV Operation—Main Living Area	84
2. TV Signal Booster	84
3. Cable/Satellite Outlet	85
4. Winegard AIR 360 Lo Profile Operation	85
5. Vision S+ Camera System	86
6. Starlink Prep Package	86

SEC.15 FIREFLY RV CONTROL SYSTEM

A. Introduction	87
-----------------	----

SEC.16 HEATING & COOLING (HVAC)

A. Introduction	88
B. Air Conditioner With Heat Pump	88
1. Ducted A/C	88
2. Duct Work and Return Air	88
3. Heat Pump	88
4. Cooling vs Heat Gain	89
5. Air Conditioner Gasket	89
C. Furnace	89
D. Fireplace	90
E. Roof Vents	91

SEC.17 AWNINGS

A. Main Awning - Solera	92
1. Awning Extension	92
2. Retracting the Awning	93
3. Pitch Adjustment	93
B. Slide Topper Awnings – Dometic	94
1. Operation	94
C. Rear Patio Awning – Girard	94
1. General Safety	94
2. Operating the Awning	95
3. Manually Overriding the Awning	95
4. Maintenance of the Awning	95

SEC.18 APPLIANCES

A. General Information	96
B. Microwave	96
C. 120-Volt Refrigerator	96
D. Cooking With Propane	97
E. Outdoor Cook Top (If Equipped)	98
F. Oven	98
G. Range Hood (If Equipped)	98
H. Range Top With Oven	98
I. Washer / Dryer Prep	99
1. Master Bedroom Prep	99
2. Garage Prep	99
J. Dishwasher Prep (If Equipped)	99

SEC.19 PROPANE (LP) SYSTEMS

A. General Information	100
B. Maintenance	100
C. Propane Gas	100
D. Propane Gas Cylinders	101
1. General Information	101
2. Servicing or Filling	102
3. LP Gas Container Overfill	102
4. Propane Leak Test	102
5. Propane Gas Alarm	103
6. Installing the Propane Cylinders	103
E. Propane Regulator	104
F. Propane System Components	105
G. Cooking With Propane	105
H. Traveling With Propane	105
I. Operating The Propane System	106
J. Calculating Propane Use	106

SEC.20 PLUMBING SYSTEMS

A. Introduction	107
B. First Use Of The Fresh Water System	107
C. Tank Monitoring	107
D. Water Pressure Regulator	108
E. Water Pump Switch	108
F. 12-Volt Water Pump	108
G. Water Filtration System	108
H. Fresh Water Holding Tank	109
I. Water Heater—Tankless	110
1. General	110
2. Controller Operation	110
J. Bathroom Shower	111
1. General	111
2. Maintenance	111
3. Shower Door	112
K. Faucets	113
L. Exterior Spray Ports	113
1. General	114
2. Handle Position and Valve Routing	114
N. Draining The Fresh Water System	115
O. Sanitizing The Fresh Water System	115
P. Winterizing The Plumbing System	116
Q. De-Winterizing The Plumbing System	119
R. Black Water And Gray Water Systems	121
S. Toilet	121
1. General	121
2. Preventing Toilet Blockage	121
3. Cleaning and Maintenance	121
T. Black And Gray Water Holding Tanks	122
1. Black Water Tank Preparation	122
2. Gray Water Tank Preparation	122
3. Emptying Black and Gray Water Tanks	122
4. Gray and Black Tank Valve Switches, Sewer Outlet, and Sewer Hose Storage Tube	123
5. Manually overriding the Gray and Black Power Tank Valves	123
6. Dump Station Locations	124
7. Vents and Vent Pipes	125
8. Drainpipes With Dry Sealing Valve	125
9. Black Tank Flusher	125

CONTENTS

SEC.21 FURNITURE

A. Entertainment Recliner Sofa	126
B. Bedroom Dresser	126
C. HappiJac Sofa	127

SEC.22 ENTRY DOOR & STEP SYSTEM

A. Main Entry Door	128
1. Integrated Window Shade	128
2. Lippert Screen Shot	128
3. Lippert Screen Assist	128
4. Lippert Screen Defender	128
5. Keyless Entry	128
6. Telescoping Handrail	129
7. Main Entry Door Step System	130
B. Garage Entry Door	131
1. Lippert Screen Shot	131
2. Lippert Screen Assist	131
3. Lippert Screen Defender	131
4. Keyed Lock	131
5. Grab Handle	131
6. Garage Entry Door Steps	131
C. Compartment And Entry Door Keys	131

SEC.23 RAMP DOOR & PATIO

A. Ramp Door Operation	132
1. Exterior Operation	132
2. Interior Ramp Door Operation	133
3. Patio Position	134
4. Ramp Position	135
B. Patio Kit	136
1. Setting-Up The Patio:	136
C. 3-Seasons Door	139
1. Opening the Center Door	139
2. Opening the Full Door	140

SEC.24 ACCESSORIES

A. Interior Accessories	141
1. Pantry	141
2. Silverware Drawer	141
3. Bathroom Storage	142
4. Recessed L-Track	142

SEC.25 RV EXTERIOR CARE

A. General	143
B. Exterior Cleaning	143
C. Washing	143
D. During Cold Weather	144
E. RV Waxing	144
F. RV Polishing	144
G. Damaged Paint	144
H. Plastic Components	145
I. Chrome Parts (If Equipped)	145
J. Exterior Roof	145
K. Sidewall Vents	145
L. Sealants	145
M. Roof Ladder	146
N. RV Frame/Chassis	146
O. Windows	146
P. Ramp Doors And Patio Rail Kits	146
Q. RV Storage Preparation	146
R. Snow Removal	147

SEC.26 RV INTERIOR CARE

A. Cleaning The Interior	148
B. Tables, Cabinets, And Drawers	148
C. Wall, Ceiling, And Cabinet Paneling	148
D. Countertops	148
E. Vinyl Flooring	148
F. Dinette Table, Dinette Chairs	150
G. Furniture Upholstery	150
I. Décor	151
J. Shower Walls	151
K. Sink And Shower Fixtures	151
L. Stainless Steel Sink And Appliances (If Equipped)	151

SEC.27 MAINTENANCE

A. Maintenance Checklist	152
1. Prior to Your First Trip in Your RV	152
2. Each Trip	152

SEC.01 INTRODUCTION

A. ABOUT THIS MANUAL

The Brinkley RV Owner's Manual is intended to safely guide you through the proper use and maintenance of your Brinkley RV along with its unique components and features. Understanding the operational procedures of your Brinkley RV will allow you to better understand how to use your RV and, in turn, maximize your RV experience.

Please know, this manual is not intended to be inclusive of every and all operational aspects of your RV. The separate component and appliance owner's manuals should also be thoroughly reviewed. Because there are various options that may be selected within the build of each RV, each Brinkley RV may contain options, features, and/or components that are not included on your RV.

We wish that we could provide you with all the information required to ensure your safety during towing, transportation, and camping. The campsites you choose, your tow vehicle, and the road conditions you encounter along your journey are too numerous for us to cover all the potential scenarios.

You are ultimately responsible for the safe use, operation, and transportation of your RV.

If you have questions related to safety, please contact us. We will gladly provide you with additional guidance related to your specific camping and transportation scenarios.

Additionally, due to our dedication to continuous product improvements and updates, some photographs, components, systems, and diagrams may be different from what is supplied within this manual. If we can make our products better, we will strive to make those improvements as quickly as humanly possible.

At the time of publication, this information is accurate, but is subject to change at any time without notice. You can access the most up-to-date version of the Owner's Manual by visiting our website, www.BrinkleyRV.com or by scanning the QR code located on the back cover of this Owner's Manual.

If you happen to have any additional questions or concerns, or simply need assistance of any kind, please do not hesitate to reach out to your Brinkley RV Dealer or the Brinkley RV Customer Care Team. Below, you will find our contact information. Our contact information is also located at the bottom of each page of this manual. Remember, we are just one phone call away.

CONTACT INFORMATION:

Email: CustomerCare@BrinkleyRV.com

Phone: (574) 501-4280 or toll free
(888) 502-3460

Address: Brinkley RV
Attn: Customer Care
1655 Brinkley Way East
Goshen, IN 46528

B. OWNER INFORMATION PACKAGE

Within your RV, you will find an Owner's Information Package that contains the Owner's Manual, Warranty Guide, Component Manuals, and Warranty Registrations for the appliances and components within your new Brinkley RV.

Before Using Your RV, it is vital you read all documents within the Owner's Information Package. Your safety is important to us, and we want you to have the best possible experience with your Brinkley RV.

+ NOTICE

Some component manuals will not be provided within your Owner's Information Package and can only be found on line via the component supplier website.

Register and activate your component warranties within the required time frame to avoid loss of warranty coverage. Please note that there are some component manufacturers who provide additional warranties beyond that of the Brinkley RV Limited Base and Structural Warranties. Please See the separate Warranty Guide for additional details.

+ NOTICE

It is highly recommended that you have your selling Dealer register your warranties. It is their obligation to register your warranties on your behalf at the time of sale. Registering at the time of sale ensures that you are afforded the full benefit of all warranties.

C. MANUFACTURING CERTIFICATIONS

All Brinkley RVs are required to meet and/or exceed the safety and manufacturing codes, regulations, and standards of the Recreational Vehicle Industry Association (RVIA).

RVIA and Transport Canada both conduct random product audits on a frequent basis to ensure that all Brinkley RVs are manufactured to U.S. (RVIA) and Canadian (CSA) standards.

Depending on where the RV is being transported and sold, an RVIA and/or CSA Group label can be found on the sidewall next to the main entry door. This label confirms that your RV has been manufactured to the required codes and standards of RVIA and/or CSA.

+ NOTICE

The RVIA and CSA Codes and Standards are not identical and can vary from each other depending on their requirements.

Content within the Brinkley RV Owner's Information Package including the Owner's Manual, Warranty Guide, Component Manuals, etc, should be considered a permanent component of the RV. In the event this RV is traded or sold, all documents should remain within the RV for the next owner.

SEC.01 INTRODUCTION

D. VEHICLE IDENTIFICATION NUMBER

Each Brinkley RV is assigned a 17-digit vehicle identification number also referred to as the “VIN.” This identification number is located on the VIN tag which can be found on the A-frame of a travel trailer or the hitch (also known as the pin box) on fifth wheels. As a secondary location, the VIN can also be found on the Federal Certification Label See [Section 5C\(3\)](#).

Please see the typical de-coding of a Brinkley RV VIN below:

+ NOTICE

The last seven (7) digits of the VIN are also known as the RV serial number. For example, using the supplied VIN below, the serial number would be G000001.



SAE WORLD IDENTIFIER:
7T0 – BRINKLEY RV

CLASS:
F = FIFTH WHEEL
T = TRAVEL TRAILER

BRAND:
Z – MODEL Z
G – MODEL G
A – MODEL Z AIR
1 – MODEL I
2 - MODEL Ix
X - MODEL Gx

LENGTH:
THIS NUMBER IS A GROUPING NUMBER PREDETERMINED BASED ON THE SPECIFIED GROUP THE RV LENGTH FALLS WITHIN RATHER THAN THE ACTUAL LENGTH OF THE RV.

MODEL YEAR:
N – 2022
P – 2023
R – 2024
S – 2025
T – 2026

E. SAFETY PRECAUTIONS

There are many safety precautions you should be aware of and take while enjoying your RV. These include but are not limited to:

- **Safety during the transportation of our RV.**
- **Functional safety while utilizing all RV components and features.**
- **Environmental safety while visiting different locations.**
- **Occupant safety while staying in the RV over the course of your trip.**

Safety is, and should be, exercised in every aspect of your RV experience. The personal safety of you, your family, and those around you are of the greatest importance to us at Brinkley RV.

Many appliances and related equipment within the RV (stove, outdoor grills, generator, water heater, furnace, etc.) will operate utilizing propane and/or will exhaust carbon monoxide. While using these items or any other related potential safety hazard, it is crucial that safety remains your number one priority. Be sure to follow all instructions and warnings related to your RV referenced in this manual as well as each supplier's component manual.

Below is a guide to the common safety related symbols utilized throughout this manual to ensure that you are aware of potential safety concerns:

DANGER

This indicates an imminent hazard that, if not avoided or handled correctly, will result in death or serious injury.

WARNING

This indicates a potential hazard that, if not avoided or handled correctly, may result in death or serious injury.

CAUTION

This indicates a potential hazard that, if not avoided or handled correctly, may result in minor or moderate injury.

NOTICE

This is used to address best practices that should be utilized and do not commonly result in injury but may lead to property damage if not careful. Notices are also utilized throughout the manual to call attention to important information that you should be aware of.

F. ADDITIONAL TERMINOLOGY USED

Customer Supplied

Indicates any and all aftermarket items not installed, provided, or included with the RV as built by Brinkley RV. Any item deemed "Customer Supplied" is not covered under the Brinkley Limited Base Warranty or Limited Structural Warranty.

If Equipped

Indicates any and all items that may be included and/or installed by Brinkley on a particular RV. All items referred to with the phrase "If Equipped," must be installed during the manufacturing process and cannot be installed or added at a later date. The phrase "If Equipped" does not imply or suggest such items are available, supplied, or included with any given Brinkley RV.

Optional

Indicates any and all items that may be an option and/or feature added to a particular Brinkley RV. Some "Optional" items and/or features can only be installed within the manufacturing process and cannot be added as an aftermarket item. The term "Optional" does not imply or suggest such items are available, supplied, or included with any given Brinkley RV.

SEC.02 REPORTING SAFETY DEFECTS

A. HOW TO REPORT SAFETY DEFECTS

To ensure safety, from time to time, a recall may be initiated to prevent a possible product failure from manifesting into something greater. A Safety Recall includes any possible malfunction that may lead to personal injury and/or property damage. If a recall is deemed necessary, a notice will be mailed to your address on file and emailed, if an email address has been provided by you. Please be sure that you supply Brinkley RV with an accurate home address and email address. The purpose of this process is to ensure you are notified of the recall and to ensure the RV is taken to a Brinkley Authorized Dealer or Service Center for correction prior to continuing use. For instructions on how to update your contact information, please see [Section 3G](#) of this manual.

+ NOTICE

It is very important to keep your contact information updated. It is also vital for the unit to be taken to an Authorized Dealer or Service Center to remedy the concern prior to using the RV or related component again.

If you believe your vehicle may contain a defect that can lead to injury, accident, property damage, or death, both Brinkley RV and the National Highway Traffic Safety Administration (NHTSA), should be notified immediately. In the circumstance NHTSA receives multiple complaints on an issue, an investigation will be opened for review. This is to assist in the determination process required to locate the safety concern and to launch a recall and a remedy campaign (if needed). If NHTSA finds that a safety defect exists in any group of RV's, it may order a recall and require a remedy campaign. Once a recall is established, NHTSA cannot become involved with any action or circumstance between you, the Dealer, and/or Brinkley RV.

All communications related to the recall must be handled by Brinkley RV, your Dealer, and you as the owner of the RV.

A Service Campaign may also be launched for a potential product failure. Unlike a recall, a Service Campaign is less severe in that the product failure is not likely to lead to personal injury. And, unlike a recall, the correction process for a Service Campaign is not mandatory but is highly recommended.

Recalls and Service Campaigns can be found on the NHTSA website. As a reminder, this information will also be mailed to the contact information on the RV file.

TO CONTACT NHTSA IN THE UNITED STATES:

Please visit their website at www.safercar.gov; call their toll-free hotline at 1 (888) 327-4236 (Hearing impaired (TTY): 1 (800) 424-9153); or send your correspondence to:

NHTSA Headquarters
Attn: Administrator
1200 New Jersey Avenue SE
Washington, DC 20590

TO CONTACT NHTSA IN CANADA: (Known as "Transport Canada")

Please visit their website at www.tc.gc.ca; call their toll-free hotline at 1 (800) 333-0510 (819) 994-3328 in the Gatineau-Ottawa area or internationally), or send your correspondence to:

Transport Canada-ASFAD
330 Sparks St.
Ottawa, ON K1A 0N5

A. DEALER'S RESPONSIBILITIES

At the time your Brinkley RV is purchased, your Dealer is expected to:

1. **DELIVER your RV in the best condition possible.** Your RV must pass the Dealer's Pre-Delivery Inspection (PDI). This inspection tests all systems and components. No Brinkley RV should leave a Dealer's lot without first ensuring that all systems and components are in proper working order.
2. **PROVIDE an orientation to familiarize you with how to operate all systems and components of your new RV.** This orientation is extremely important to ensuring you understand how to properly use the RV prior to camping. Brinkley RV requires its Dealers to provide you with a comprehensive walk through of the RV prior to you leaving their Dealership. You should ask as many questions as possible to ensure you are prepared to safely utilize your Brinkley RV and that you are trained on the use of all the features of the RV. Please contact us directly if the orientation is not completed to your satisfaction.

+ NOTICE

THE ORIENTATION IS THE MOST IMPORTANT PART OF THE RV PURCHASE PROCESS. This is your opportunity to ask as many questions as possible. The most common frustrations generally result from a lack of understanding how to properly use the various systems of the RV as well as a basic understanding of how the batteries and electrical systems work.

3. **REVIEW with you and explain the provisions of the Limited Base Warranty and Limited Structural Warranty.** It is our goal to ensure that you understand your rights and responsibilities to gain the complete benefit of the warranties afforded to you. These warranties, as well as the additional component and appliance warranties, are summarized in the separate Brinkley RV Warranty Guide. If you have questions, please contact us.

4. **SEND your completed Warranty Registration and New Vehicle PDI Checklist to Brinkley RV.** Your Warranty Registration Form is required to be submitted within fourteen (14) days of the RV delivery date to activate your warranty coverage. We expect every Brinkley RV Authorized Dealer to assist you with your warranty registrations and to complete this process prior to you leaving the Dealership. We expect the registrations will be completed by the Dealer on the actual date of purchase. We provide fourteen (14) days from the purchase date to ensure you are afforded adequate time to register. Please contact us immediately if your Dealer did not assist you in registering your warranties.
5. **ENSURE that you receive a complete Owner Information Package.** Your Dealer must ensure that you obtain a copy of the Brinkley RV Owner's Manual, individual component manuals, and Warranty Guide.
6. **EXPLAIN how to obtain local and out-of-town service for your RV, and its components and appliances.** It is our goal to ensure you know how to obtain service regardless of whether or not the service is covered by your warranties. If your RV has an issue, we want to ensure that it is promptly fixed. You can always contact us directly at any time for assistance.
7. **SERVICE all Brinkley RV products.** Each and every Brinkley RV Authorized Dealership is required to provide service on all Brinkley RV products. RVs are intended to permit you to travel across North America and explore all it has to offer. If you are traveling and cannot access your selling Dealership, please consult our website for both a Dealer and Mobile Service Locator or call Brinkley Customer Care for assistance.

SEC.03 SERVICE & WARRANTY

+ NOTICE

To activate your Brinkley RV One (1) Year Limited Base Warranty and Three (3) Year Limited Structural Warranty you MUST complete the Warranty Registration within fourteen (14) days of purchase. In addition to the Brinkley registration, you must also complete the required component registrations. If you fail to do so, our suppliers will honor their warranties based on the Brinkley registration submitted upon purchase. All warranties start on the date of purchase and are in effect for their stated durations. Your Dealer is required to help facilitate all warranty registrations at the time of purchase. If you do not register your RV within the required time frames, warranty may be forfeited.

B. OWNER'S (YOUR) RESPONSIBILITIES

Routine care and maintenance of your RV is a part of owning your Brinkley RV. The conditions of the roads and highways you encounter as well as exposure to weather and the elements can all take a toll on the condition of your RV. As such, it is your responsibility to care and maintain your Brinkley RV in accordance with the Warranty Guide, component manuals, and this manual. Proper maintenance will improve the longevity of your RV and will prevent situations where warranty coverage is lost due to neglect.

In the circumstance warranty repairs and/or service is needed, it is your responsibility to transport the RV to and from your Authorized Dealer. We ask that you always first attempt to obtain the needed warranty service work through your selling Brinkley RV Dealer. However, if this is not possible for any given reason, Brinkley RV is more than willing to assist you in locating alternatives. Please do not hesitate to contact us at any time. It is also highly recommended that you obtain insurance coverage on your RV. This coverage will afford you protection for or against personal liability, collision, theft, property damage, etc.

C. OBTAINING WARRANTY SERVICE

In the event you feel you need to take your RV to an Authorized Dealer for service work of any kind, please first follow the steps below to validate your concern and to obtain service work:

1. **Verify your complaint.** There is nothing more frustrating than transporting your RV to your Dealer just to find out your RV is operating correctly, is functioning within normal conditions of the RV, or was not used correctly. There are many instances where your Dealer or Brinkley RV can help you before you become frustrated and spend time trying to obtain service.
2. **Make a list.** If service is truly required, you should also make a prioritized list of all repairs needed and provide this list to the Dealer or Authorized Service Center at the time of scheduling service. We want to ensure that the Dealer or Authorized Service Center schedules enough time to address all your service concerns and they can obtain all necessary parts in advance of your service appointment. The checklist will also help to ensure that the Dealer addresses all your concerns at the time of service.

+ NOTICE

It is very common for service to be delayed due to the parts not being available at the time of service. RV Dealers generally carry many different brands and models of RV's making it difficult to stock all parts required for service. Some replacement parts may take several weeks for the Dealer or Authorized Service Center to obtain. The better you communicate your service needs, the better your service experience will be.

3. **Be prepared.** Prior to calling your Dealer or Brinkley RV, make sure you have your warranty list prepared, the VIN, and any related past service/maintenance paperwork available. Being prepared is critical to ensuring speedy and accurate resolution of your service issues.
4. **Call ahead.** Due to demand, it is best to contact your Dealer to schedule your service appointment several weeks prior to using your RV. Please take into the account that if parts are needed, repair time may be extended. Holiday schedules may also impact scheduling time.

+ NOTICE

To improve efficiency, any time you reach out to your Dealer or Brinkley RV, please have the name of the individual on the registration, your RV's 17-digit Vehicle Identification Number (located on the A-frame of a travel trailer and on the hitch of a fifth wheel), date of purchase, and a detailed description of your complaint(s).

5. **Drop off your RV.** Dealers will ask for your RV to be dropped off. This will give them time to properly verify your complaint, identify the cause, and make the correction. Note that there are also instances where service may be able to be performed by a mobile technician. Calling ahead to confirm whether drop-off is required will save you time and reduce frustration.
6. **Inspect your RV at pick-up.** Prior to picking up your unit, inspect all repairs thoroughly. It is vital to address any concerns or dissatisfaction immediately. You should feel empowered to ask as many questions as you have related to your RV service as your satisfaction is of the utmost importance. If a problem reoccurs after leaving the Dealership, contact the Dealer's Service Manager along with Brinkley RV, to quickly address and resolve the issue.

D. EMERGENCY WARRANTY REPAIR

Emergency warranty repair while you are traveling includes any issue that: (1) prevents the total use of the RV, (2) poses a safety risk, and/or (3) if not remedied, will result in additional damage to the RV. To help you better understand what constitutes an emergency warranty repair, please see the below examples:

EMERGENCY EXAMPLES

(Affects safety and/or prohibits use of the RV.)

- Slide-outs will not extend or retract.
- Damage to axles, running gear, wheels or tires prohibits safe transit.
- Damage to any safety equipment required for safe transit or use.
- Gas leaks of any kind.
- Awning will not retract to permit safe transit.
- Jacks will not retract to permit safe transit.
- Refrigerator does not operate.
- Any other item that, if not remedied immediately, could result in personal injury or property damage.

NON-EMERGENCIES

(Items that are frustrating, but do not pose safety risks or loss of RV use.)

- Any cosmetic issues (scuffs, scratches, dings, etc.).
- Components or appliances not functioning properly but do not pose safety risks (TVs, stereo equipment, washer, and dryer, etc.).
- Plumbing leaks that will not further damage the unit if left unresolved.
- Non-functioning power awnings.
- Any other items that do not pose a risk to the health and safety of the occupants and others and do not render the unit unusable or uninhabitable.

SEC.03 SERVICE & WARRANTY

We understand that non-emergency issues with your RV are still frustrating. However, they should be resolved utilizing the normal service process. Special service priority is given to RVs that require the types of emergency repairs listed above. Should you encounter the need for emergency warranty assistance while in transit, please follow the below process.

- 1. Locate the nearest Authorized Brinkley RV Servicing Dealer** A Dealer Locator Map can be found at www.brinkleyrv.com/dealer-locator/ or contact Brinkley RV Customer Care Monday-Friday 7am–5pm EST at (574) 501-4280 or toll free at (888) 502-3460 or via email at CustomerCare@BrinkleyRV.com.
- 2. If you are unable to locate a local Authorized Dealer**, it may become necessary to use a non-authorized service provider or mobile service. When locating a non-authorized service provider or mobile service, it is best to search online, through resources provided by a local campground, by contacting your Dealer, or with the assistance of the Brinkley RV Customer Care Team.
- 3. If you are able to utilize a local Authorized Dealer or Service location**, please proceed as stated in the process provided in Section 3C above.

+ NOTICE

Brinkley RV is more than willing to work through a non-authorized service provider to help you obtain the service that you need. However, please keep the following in mind: (i) Service calls are not covered under warranty, (ii) Brinkley will need to approve the repair estimate PRIOR to the work being performed, (iii) we may choose to ship the needed parts versus permit substitutions or use of locally available alternatives, (iv) defective parts may be required to be returned, and (v) payment must be made by the Customer and the Brinkley RV pre-approved estimate will be reimbursed post-repair.

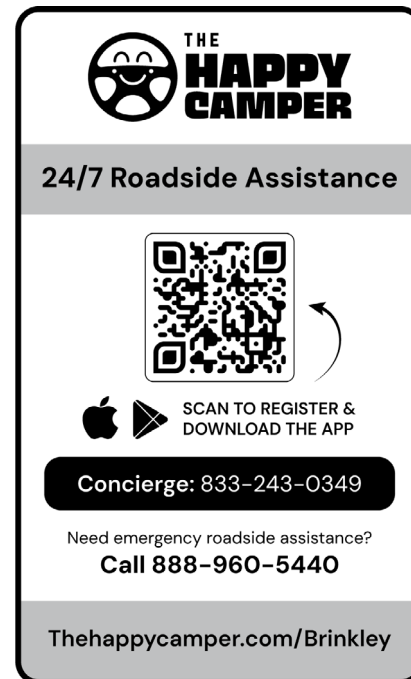

24/7 Smart Roadside Assistance (Complimentary for 1 Year from Date of Purchase of your Brinkley RV)

Enjoy comprehensive coverage with expanded benefits:

- Towing: Your vehicle is towed to the nearest qualified repair center—or to a center of your choice if it's equidistant.
- Lockouts: Whether you're locked out of your vehicle or your home, our locksmith services help you regain access. (Replacement key charges are reimbursable as approved.)
- Tire Service: We repair damaged tires. If non-repairable, we'll install your inflated spare. Need a new tire? We cover one replacement tire per year.
- Battery Service: Jump starts and minor emergency mechanical adjustments get you moving.
- Fluid Delivery: Emergency delivery of gasoline, diesel, oil, water, or other needed fluids (liquids are at your cost).
- Winching: Extrication from ditches, snow, mud, or sand—provided your vehicle is within 100 feet of a maintained roadway.

Premium Add-On Benefits

- RV Technical Assistance: Access expert advice from RVIA and ASE Certified mechanics for technical queries.
- Mobile Mechanic: If your RV needs on-site repairs, we'll dispatch a qualified mobile mechanic (repair and parts fees apply).
- Key Replacement: Lost your RV key or key fob? We'll replace it once per year.
- RV Repair Appointment Setting: We assist in locating the right repair provider when needed.
- Emergency Travel Assistance: If a collision (more than 100 miles from home) interrupts your trip, you may qualify for reimbursement up to \$2,000 per occurrence with sub-limits:
 - Auto Rental: \$400
 - Air Transportation: \$1,000
 - Hotel/Motel/Campground Fees: \$400
 - Meals: \$200

For Emergency Roadside Assistance:

- Call Toll-Free: (888) 960-5440
- For Reimbursement & Claims:
- Submit documents in app or call concierge services (833) 243-0349
- When filing a claim, please have the following handy:
 - Photos of the issue (if applicable)
 - Signed invoice
 - Proof of loss
 - Any additional documentation as requested

E. REPLACEMENT PARTS

Brinkley RV and its Authorized Dealers and Service Centers are the exclusive providers of parts. As a general rule, we recommend you first contact your selling Brinkley RV Authorized Dealer. If an original part is no longer available, Brinkley RV and/or your Dealer will provide an alternative replacement. As always, we are here to help you. Please contact the Brinkley RV Customer Care Team whenever you feel it is necessary to ensure you get the assistance that you need.

F. AFTERMARKET INSTALLATIONS OR ALTERATIONS

Aftermarket installations or alterations to your RV and its parts and components are not covered under any warranty provided by Brinkley RV or the warranties of its component suppliers. In addition, such modifications void any warranty to any related part or location that was possibly affected or changed by the modification made. Whoever performed the work for the alterations or modifications holds the sole responsibility and liability of the work performed and any related warranty. Brinkley RV is not responsible for the safety or quality of modifications performed nor its related parts, materials, or workmanship of the provider.

G. UPDATING YOUR CONTACT INFORMATION

Updating contact information and new owner information is vital. In the event the RV was stolen, totaled, destroyed, has changed ownership, or personal contact information has been changed, Brinkley RV should be notified right away.

It is required by federal law that Brinkley RV maintain and keep records of products and Brinkley RV owners. These records ensure we can promptly reach out to current owners in the event of a Recall, Service Campaign, or other necessary Customer notification.

+ NOTICE

To update your contact information, please email CustomerCare@BrinkleyRV.com with the subject line "Contact Information Update" or mail the updated information to:

Brinkley RV
 Attn: Customer Care
 1655 Brinkley Way East
 Goshen, IN 4652

For questions, please contact Brinkley RV Customer Care at (574) 501-4280 or toll free (888) 502-3460.

SEC.04 OCCUPANT SAFETY

Your Brinkley RV is designed to include the features and functions we believe will help provide the ultimate Customer Experience. Rest assured that the safety of you, your family and your RV are of the utmost importance to us. Your Brinkley RV is designed to meet and/or exceed all safety codes and standards provided by RVIA, or Transport Canada if shipped to Canada, or otherwise required by law at the time it is manufactured.

It is our priority to ensure all safety items are properly and carefully installed to ensure the safety of all occupants within your RV. To further ensure the safety of you and others, please carefully and completely read and understand this Section.

A. DEVELOP A FAMILY SAFETY PLAN

In case of emergency or severe weather, a Safety Plan should be developed in advance for you, your family, and any other occupants. Be proactive and practice your plan with your RV occupants, especially if children are involved.

1. Prior to using your RV, know where all doors, emergency exit windows, and safety equipment are located.
2. Know where the safety alarms are within your RV, and what it means if they are triggered. Educate everyone on how to properly evacuate the RV. If children are involved, please stress the importance of evacuating the RV with or without an adult in the event of an emergency.
3. Plan a minimum of two (2) ways to evacuate the RV. See also [Section 4D](#) pertaining to Egress Windows for additional information. The first form of exit can include the RV entry door, but the other planned route should not. It may be essential to practice blindfolded. In a real fire situation, smoke may make it difficult, if not impossible, to see.

4. In the case of a fire, make sure everyone knows how to check doors for heat and to leave the door closed if hot; stay low while moving; and avoid inhaling smoke, fumes, and/or gases as much as possible. Placing a cloth over your mouth and nose will assist in protecting you against inhalation of smoke, fumes, or gases.
5. Plan a meeting location near the RV but a safe distance away. Everyone should remain at this location until every occupant is accounted for.
6. Make sure everyone knows how to call 911 from outside the RV and where to go if they do not have a phone. A family emergency contact should also be established and memorized.
7. Safety drills should be discussed and practiced as needed every six (6) months or as frequent as necessary to ensure everyone's safety.

WARNING

WHEN IN A FIRE RISK ZONE, ADHERE TO ALL FIRE AND SAFETY RESTRICTIONS THAT APPLY.

WARNING

BE CAUTIOUS OF THE HEAT INDEX. WHEN CAMPING IN HIGH TEMPERATURE CLIMATES. KEEP HYDRATED AND STAY IN AIR CONDITIONED LOCATIONS DURING A HEAT INDEX WARNING.

B. EMERGENCY WEATHER PLANNING

1. General Information

It is very important to monitor weather conditions while camping. Weather is known to change with little to no warning and can put you, the RV, the tow vehicle, and all occupants at risk. Local weather stations that broadcast on TV and radio often provide updated weather conditions and warnings as they occur. Be sure to stay tuned as you are traveling and using your RV. Knowing how to deal with severe weather conditions is important to ensure you and your family's safety. If traveling to an area where weather is known to suddenly shift, a weather radio is recommended.

Weather radios broadcast 24-hour VHF weather observations and forecasts directly from the US National Weather Service (NWS). Frequencies used by the US National Oceanic and Atmospheric Administration (NOAA) weather radio are 162.400, 162.425, 162.450, 162.475, 162.500, 162.525, or 162.550 megahertz (MHz). You can also visit their website at www.noaa.gov.

WARNING

DURING SEVERE WEATHER CONDITIONS SEEK SHELTER INDOORS OR AS DIRECTED BY THE CAMPGROUND AND/OR APPROPRIATE LOCAL AUTHORITIES.

+ NOTICE

Many emergency shelters do not permit the entry of pets due to health-related reasons and limited space. You as the owner are responsible to create a safety survival plan for your beloved pets. It is also recommended that the plan include a three (3) day supply of food and water for all occupants.

2. Repairing Severe Weather Damage

Please contact your insurance provider right away if your RV is damaged by severe weather. Contacting your insurance provider is required PRIOR to the repair(s) being scheduled and/or performed. Weather damage is covered exclusively by your insurance coverage and is not covered by Brinkley RV or its component manufacturers.

C. FIRE SAFETY

1. General Information

The most common fire safety issues include, but are not limited to, smoking in bed, using flammable solvents and/or cleaning fluids, and leaving children unattended.

2. Fire Emergencies

IN A FIRE EMERGENCY, EVACUATE THE RV FIRST, THEN CALL 911 FROM A SAFE LOCATION.

- In a fire emergency, execute your Family Safety Plan as outlined in Section 4A.
- Ensure everyone knows to stop, drop, and roll if their clothes or hair catch on fire.
- The basic protocol for stop, drop and roll is as follows:
 - **STOP** in place, do not run.
 - **DROP** to the ground.
 - **ROLL** back and forth, hands over your face.



SEC.04 OCCUPANT SAFETY

3. Common and Important Fire Safety Information

Below is a list that includes common information related to fire safety. This list is not all inclusive of all rules related to fire safety. Common sense and attention to your surroundings may dictate additional guidance and protections that are required to prevent the spread of fire. Please use this list as a guide to ensure that fire safety is ALWAYS practiced by you, your family and other occupants of your Brinkley RV:

- **ALWAYS** supervise children around or near any open flames, especially grills, fire pits and campfires.
- **ALWAYS** learn and teach fire safety, prevention, and fire extinguishing practices.
- **ALWAYS** build campfires, place grills, or otherwise utilize open flames away from nearby trees or bushes and adhere to all federal, state and local laws related to fires and burning, including local burning bans and advisories. It is critical to always know and adhere to the restrictions in place for your location. Forest and field fires can be catastrophic to safety and property alike and can quickly spread.
- **ALWAYS** maintain at least a three (3) feet of clearance around grills, campfires, your RV, tents, and other structures or combustible materials. This three (3) foot zone should be free of leaves, dry grass, pine needles, or any other combustible substances to prevent the spread of fire.
- **ALWAYS** proactively have an action plan in place to rapidly and completely extinguish a campfire or other open flame.
- **ALWAYS** teach family members and RV occupants how to locate and properly use the fire extinguisher.
- **ALWAYS** replace your fire extinguisher as recommended by the manufacturer of the extinguisher.
- **ALWAYS** call the Fire Department, no matter how small the fire may seem.
- **ALWAYS** assume that, where there is smoke, there may be fire.
- **NEVER** store combustible materials in enclosed areas or near any heat source.
- **NEVER** leave a fire burning unattended. An ember or unextinguished cigarette can cause a fire to quickly spread out of control during dry conditions.
- **NEVER** use water to put out a grease or electrical fire. Utilizing water can spread grease fires and can create an electrocution or shock hazard during an electrical fire.
- **NEVER** assume that your family and other RV occupants are aware of and practice fire safety. It is your responsibility to ensure that everyone is prepared in the event of fire.

Additional information pertaining to fire safety and firefighting can be located at the National Fire Protection Association (NFPA) website www.nfpa.org.

+ NOTICE

Notify Brinkley RV immediately if you feel that a product failure resulted in a fire. Please call Brinkley Customer Care at (574) 501-4280 or toll free (888) 502-3460 for approval before you re-enter the RV, have it moved or repaired, or any debris is removed or cleaned from the unit. A failure to notify Brinkley RV in advance could result in a loss of warranty coverage.

4. Fire Extinguishers

a. General Information

Fires can spread rapidly. Prior to reaching for the fire extinguisher, remember your Family Safety Plan. See [Section 4A](#) and remember that safety is the priority. Property can be replaced. People and pets cannot. If a fire starts in or around your RV, **SAFE EVACUATION OF ALL OCCUPANTS FROM THE RV IS THE FIRST AND UTMOST PRIORITY.**

A dry chemical, Class B/ Class C type fire extinguisher is located near the entry door of your RV. The provided portable fire extinguisher should be utilized on small fires or to help contain larger ones until the fire department arrives on site. Portable extinguishers do have limitations and remember to always put your safety first.



Household fire extinguishers are classified into four types by Underwriters Laboratories (UL):

RATING	INTENDED USE
TYPE A	FOR USE ON FIRES INVOLVING COMBUSTIBLE MATERIALS SUCH AS WOOD, CLOTH AND PAPER.
TYPE B	FOR USE ON FLAMMABLE LIQUID FIRES, INCLUDING KITCHEN GREASE. NEVER USE WATER ON THIS TYPE OF FIRE.
TYPE C	FOR USE ON FIRES INVOLVING ENERGIZED ELECTRICAL EQUIPMENT.
TYPE ABC	WORKS ON ALL THREE TYPES OF FIRES LISTED ABOVE.

b. Operation

When utilizing a fire extinguisher, it is vital to keep your back facing a clear and safe exit to maintain a safe escape route. Stop and evacuate immediately if the fire cannot be contained or if smoke fills the room.

TO OPERATE A FIRE EXTINGUISHER, REMEMBER THE WORD: **P.A.S.S.**

PULL the pin. Hold the extinguisher with the nozzle pointing away from you and release the locking mechanism.

AIM low. Point the extinguisher at the base of the fire.

SQUEEZE the lever slowly and evenly.

SWEEP the nozzle from side-to-side until the fire is out.



c. Disposal

For disposal of used fire extinguishers, contact your local fire, sanitation, or environmental protection department for rules and regulations applicable to their safe disposal.

SEC. 04 OCCUPANT SAFETY

D. EMERGENCY EGRESS WINDOWS

1. General Information

The entrance door is and should be your primary exit. In a situation where the entry door has been compromised, the **Emergency Egress Window (or exit window) should be your secondary exit route. All egress windows are clearly marked with an 'EXIT' label and have red handles for window operation.** See the picture below as an example. Some egress windows include the entire window. There are instances, however, where only a part or portion of the window is intended for egress. It is important to learn the proper use of all Emergency Egress Windows and practice how to operate them prior to an emergency occurring.



Please review and follow the additional information below:

- **ALWAYS** ensure the Egress Windows are not blocked by trees and/or any other obstacles when setting up your campsite.
- **ALWAYS** ensure that the ground around the outside of the RV at the egress window location(s) provides solid ground and an easy escape route.
- **ALWAYS** review proper escape routes in case of an emergency.
- **ALWAYS** locate all Egress Windows and review proper operation with all occupants within the RV.
- **ALWAYS** determine in advance the order of

who will exit through the egress window and how it will be performed. • Before exiting an Egress Window, if possible, place a blanket over the frame for protection.

- **ALWAYS** ensure that the last person to exit the RV, in the case of a fire, knows how to help others escape.
- **ALWAYS** ensure that all occupants of the RV know the predetermined meeting location if an emergency ensues.

2. Maintenance

To prevent the Egress Window seals from sticking, periodically open and close the windows. Before traveling, always make sure ALL windows are locked. It is important to ensure that all locks work properly and that Egress Windows operate properly prior to using the RV. Failing to lock windows prior to transit may result in wind damage to the windows.

E. SMOKE ALARM

1. General Information

On the ceiling of your RV, you will notice a smoke alarm in the main living area. The smoke alarm is intended to alert you as soon as smoke is detected to reduce the risk of personal injury, property damage, or even death from smoke and/ or fire. Although smoke alarms are intended to provide you with enough notice and time to escape before a fire spreads, it is important to understand they are not foolproof. Smoke alarms will only be triggered when smoke reaches their sensors. Although a smoke alarm is a necessary safety alert system, common sense and your own senses should be

utilized to ensure the safety of you, your family, and any RV occupants at all times.

- It is crucial for smoke alarms to be properly located, installed, and maintained.
- Smoke alarms should not be tampered with and should be inspected on a continuous basis.
 - When the smoke alarm battery is supplying power, a red LED light will flash.
 - If the light is not flashing or if the alarm is chirping, the battery should be changed immediately.
 - A smoke alarm will not function correctly if the battery is missing, installed incorrectly, or is not the correct battery type.
 - If the battery is correctly replaced, and the alarm is still not functioning, replace the alarm.
- If smoke is detected by the alarm, it will trigger the audible alarm until the air is cleared.
- Those who have loss of hearing or specific medical conditions relating to hearing loss should consider using alarms that offer both audible and visual signals. Smoke detectors with visual alarms are NOT installed in your Brinkley RV from the factory.

IF THE SMOKE ALARM SOUNDS:

When the alarm is triggered, a loud repeating alert or siren will sound and the light on the smoke alarm will rapidly flash red.

- The alarm signals that smoke has been detected and requires your immediate attention.
- Never ignore an alarm if it is triggered. Doing so may result in injury or death.

- When the alarm is triggered and it is evident there is a fire, evacuate the RV immediately.
- After you are a safe distance from the RV, call 911.
- Always refer to your Family Safety Plan and ensure all occupants know the plan.

⚠ WARNING

Smoke alarms **DO NOT** function without a working battery. **DO NOT** disconnect the battery to silence the smoke alarm and **ALWAYS** make sure the alarm is working for continuous protection.

⚠ WARNING

Test all smoke alarms before every camping trip or use of your RV. This is especially important after your unit has been removed from storage and any time you have not utilized the RV for an extended period.

⚠ WARNING

Never use an open flame, such as a lighter or match, to test a smoke alarm. Doing so may result in setting fire to the smoke alarm and your RV. Always use the “Test” button on the alarm. If the smoke alarm does not signal right away, check the battery and replace the alarm as needed.

2. Testing a Smoke Alarm

It is vital for smoke alarms to be tested on a weekly basis. When testing, stay an arm’s length away from the alarm to make sure the alarm’s signal does not injure or harm your hearing during the test.

SEC.04 OCCUPANT SAFETY

SMOKE ALARM TESTING PROCEDURE:

1. **PRESS** and **HOLD** the **TEST/SILENCE** button found on the face of the alarm until the alarm sounds. The alarm may continue for a second or two after the **TEST/SILENCE** button is released.
2. If the alarm does not sound right away, check the power source (its battery) and then conduct the test again.
3. If the alarm still does not signal, **CHECK** and ensure the alarm is clean of dust and debris.
4. If the alarm still does not operate, it should be replaced immediately.

3. Maintenance

To keep the smoke alarm functioning properly:

- **NEVER** clean alarms with solvents, cleaning products, water, bleach, or any other substance that may damage the alarm.
- Carefully wipe with a clean rag or vacuum the smoke alarm at least once a month.
- **NEVER** paint the smoke alarm. Paint may clog or damage the opening of the sensing unit and prevent the alarm from functioning properly.

F. CARBON MONOXIDE (CO)

1. General Information

Carbon monoxide (CO) is a colorless, odorless, tasteless, gas produced by the exhaust of burning fuel or the incomplete combustion of carbon. Sources of CO in or around your RV may be the exhaust from vehicles, generators, heaters, gas stoves and ovens, furnaces, portable grills, and/or any other gas-powered object or appliance.

CO can be poisonous even at low levels of concentration. With exposure to CO, victims tend to first experience nausea, dizziness, a dull headache, weakness, and confusion. In many situations, CO victims dismiss the early warning signs as just not feeling well and become disoriented to the point they are unable to escape or call for help. Signs and symptoms of CO poisoning will first be observed in young children and pets and should not be ignored. Immediate action is required.



THE CO AND PROPANE GAS ALARM. SEE [SECTION 4G](#) FOR ITS LOCATION IN THE RV.

CARBON MONOXIDE (CO) POISONING SIGNS AND SYMPTOMS:

- **Mild exposure:** Dull headache, running nose, weakness, sore or watery eyes, and/or other flu-like symptoms.
- **Medium exposure:** Dizziness, drowsiness, and/or vomiting.
- **Extreme exposure:** Unconsciousness, brain damage, and/or death.

Discuss the signs and symptoms of CO poisoning with all family members.

⚠ WARNING

Many carbon monoxide victims dismiss the early warning signs as just not feeling well and become too disoriented and are then unable to escape or call for help. **NEVER** avoid early warning signs. Doing so may result in brain damage or possibly death.

⚠ WARNING

If there are other vehicles or generators running nearby, there is a chance for exhaust fumes to enter into your RV. The best protection against carbon monoxide is proper ventilation and the use of a Carbon Monoxide Alarm. To maintain proper ventilation within your RV, make sure the vents on all ventilation systems are clear of snow, leaves, or any other possible debris.

2. Carbon Monoxide (CO) Alarm

a. General Information

Carbon Monoxide Alarms will sound when the CO reaches a potentially dangerous level within your RV. Upon hearing this alarm, you should quickly evacuate your RV and remain clear of the unit until the RV is well ventilated and the alarm discontinues.

- It is crucial for CO alarms to be properly located, installed, and maintained.
- CO alarms should not be tampered with and should be inspected on a continuous basis.
- When the battery is supplying power, a red LED light will flash.
- If the light is not flashing or if the alarm begins chirping, the battery should be changed immediately.
- A CO alarm will not function correctly if the battery is missing, installed incorrectly, or is the wrong type.
- If the battery is correctly replaced, and the alarm is still not functioning, replace the alarm.

- If CO is detected by the alarm, it will trigger the audible alarm until the air is cleared. For those who may have loss of hearing or specific medical conditions relating to hearing loss, should consider using alarms that offer both audible and visual signals.

IF THE CARBON MONOXIDE ALARM SOUNDS:

1. Ventilate the RV IMMEDIATELY.

Open all possible doors and windows.

- a. **CHECK** that all occupants are accounted for.
- b. **CALL 911** for your local emergency service or fire department.
- c. **DO NOT** re-enter the RV and stay clear from its openings until the emergency responders arrive or until the CO alarm ceases due to proper ventilation and removal of the CO from the RV.

2. Confirm that another motor vehicle or nearby RV is NOT the source of the CO.

3. If the CO alarm signals again within a 24-hour period:

- a. REPEAT step 1 in its entirety.
- b. **BEFORE** continuing use of your RV, **CALL** a qualified appliance technician to inspect all appliances utilizing gas and their associated gas lines to investigate the sources of carbon monoxide entry.
- c. **IF PROBLEMS ARE IDENTIFIED** during the inspection process, service the equipment **IMMEDIATELY** and **DO NOT** continue use of your RV until repairs are completed.
- d. **NOTE** all combustion equipment not inspected and provide maintenance as needed per the supplier component manuals.

SEC.04 OCCUPANT SAFETY

⚠ WARNING

CO alarms **DO NOT** function without a working battery. **DO NOT** disconnect the battery to silence the CO alarm and **ALWAYS** make sure the alarm is working for continuous protection.

b. Testing the CO Alarm

It is vital for CO alarms to be tested on a weekly basis. When testing, stay an arm's length away from the alarm to make sure the alarm's signal does not injure or harm your hearing. Below are the testing instructions.

TESTING THE CO ALARM:

- Press and hold the **TEST/SILENCE** button found on the face of the alarm until the alarm flashes red. Once flashing, the alarm will then signal 4 times and repeat for 5-6 seconds.
- If the alarm does not signal in this manner, check the power source and then test again.
- If the alarm still does not signal, **CHECK** and ensure the alarm is clean of dust and debris.
- If the alarm still does not sound, replace the CO alarm immediately through your Dealer.

⚠ WARNING

DO NOT remain within close proximity of alarm when sounding. Exposure within close range may be harmful to hearing. When testing, stay at arm's length away.

⚠ WARNING

Never test the CO alarm with vehicle exhaust or any other form of exhaust. This may lead to permanent damage and voids your warranty. This may also lead to personal harm.

⚠ WARNING

Test all CO alarms before every camping trip or use of your RV. This is especially important after your unit has been removed from storage. If the CO detector fails to test correctly, replace it immediately. Failure to do so may result in brain damage, injury, or death.

⚠ WARNING

The CO alarm sounding indicates potentially toxic levels of carbon monoxide which may result in brain damage or death. CO alarms will only indicate carbon monoxide is present at the sensor and does not indicate CO in other possible areas.

+ NOTICE

Replacing the CO alarm yourself can void the warranty. Be sure to use your Authorized Dealer while under warranty.

c. CO Alarm Maintenance

To keep the CO alarm functioning properly:

- **NEVER** clean alarms with solvents, cleaning products, water, bleach, or any other substance that may damage the alarm.
- **ALWAYS** carefully wipe the CO alarm with a clean rag or vacuum the smoke alarm at least once a month.
- **NEVER** paint the CO alarm. Paint may clog or damage the opening of the sensing unit and prevent the alarm from functioning properly.

G. PROPANE (LP) GAS ALARM

1. General Information

Propane gas is used in many of the appliances within your RV. Examples include, but are not limited to, the furnace, water heater, ovens and cook tops, portable grills, etc. If a leak occurs, because propane is heavier than air, it will collect in lower areas. Because of this, a Propane Gas Detector is installed near the floor line of your wall in an open area.



- It is crucial for propane detectors to be properly positioned, CO and LP Gas Alarm installed, and maintained.
- Propane detectors should not be tampered with and should be inspected on a continuous basis.
- When the LED on the front of the detector is green, the alarm is active. If propane, acetone, alcohol, butane, and/or gasoline is detected by the detector, it will trigger the alarm until the air is cleared. Such chemicals can be found in deodorant, perfume, cologne, wine, adhesive, liquor, lacquer, kerosene, the propellants of aerosol cans, and most cleaning agents.
- Those who have loss in hearing or specific medical conditions relating to hearing loss should consider using alarms that offer both audible and visual signals. Alarms with visual alarms are **NOT** installed in your Brinkley RV from the factory.



IF THE PROPANE GAS DETECTOR IS ALARMED:

1. Immediately **EXTINGUISH** all flames, smoking materials, and **SHUT OFF** all gas related appliances such as the stove, heater, furnace, refrigerator, etc. **DO NOT** touch any electrical switch, use electronic devices or appliances, or cellular devices.
2. **EVACUATE** everyone from the RV immediately. Use your Family Safety Plan to safely evacuate everyone from the RV. See [Section 4A](#).
3. **OPEN** all door(s) and windows to ventilate the RV.
4. **SHUT OFF** all gas supply at the LP tank valve and any other provided source. **DO NOT** start any vehicle engine, open flame, or generator near the RV.
5. **DETERMINE & REPAIR** the source of the leak.
6. **DO NOT RE-ENTER THE RV UNTIL THE PROBLEM IS CORRECTED.**

SEC.04 OCCUPANT SAFETY

PRIOR TO USING THE LP SYSTEM OR ANY LP RELATED APPLIANCE, CONTACT YOUR DEALER OR A PROPANE GAS EXPERT TO CORRECT THE PROBLEM.

⚠ DANGER

The sounding of this device means that there is a presence of LP gas, which may result in fire and/or an explosion. Leaks generally occur in LP gas piping and/or the LP gas appliances. Follow all information found within the supplier component manuals. Failure to do so may lead to carbon monoxide poisoning, fire, and/or an explosion causing property damage, personal injury, or death.

⚠ WARNING

This indicates a potential hazard that, if not avoided or handled correctly, may result in death or serious injury.

H. INDOOR AIR QUALITY

1. Maintaining Indoor Air Quality

- ALWAYS provide proper ventilation within your RV.
 - Proper ventilation carries pollutants and emissions out of your RV.
 - Poor ventilation will cause air pollutants to gather and potentially reach dangerous, toxic levels. Heat and humidity can cause this occurrence to accelerate.
- Clean the RV on a regular and frequent basis.
- Be proactive to protect against harmful air pollutants. These include but are not limited to: molds, pet dander, cleaning agents, pollen, and carbon monoxide from the use of charcoal, propane, or other fuel types.

+ NOTICE

Children, the elderly, and those with allergies, asthma, heart disease, and/or with chronic lung disease are at the greatest risk for reactions to poor air quality.

2. Improving Indoor Air Quality

- Open windows and doors so fresh air is available inside your RV.
- Spend time outside.

CONTROL MOLD, ALLERGENS, AND OTHER SPORES:

- Fix any water leaks immediately as they are found.
- Properly ventilate the RV.
- Clean on a regular basis removing dust, dander, pet fur, water, etc.
- Do not allow water or moisture to collect within the RV.
- Keep the windows closed and periodically run your air conditioner (A/C) and/or a dehumidifier (Customer Supplied).
- Clean any mold or mildew immediately that can be seen or smelled with proper solutions. We recommend one (1) cup (236.6 ml) bleach to one (1) gallon (3.785 liters) of water as a cleaning agent.

+ NOTICE

Never mix cleaning agents that can cause chemical reactions (ex: bleach and ammonia). Do not smoke within your RV or near an entry point into your RV. Do not use bug spray within your RV.

3. EPA Recommendations

The Environmental Protection Agency (EPA) provides and recommends three (3) basic strategies to improve indoor air quality within your RV:

- **Remove sources.** By eliminating sources of pollution and their possible emissions, you will effectively improve indoor air quality. This strategy is important and effective for the following pollutants:
 - **Biological Contaminants:** bacteria, molds, mildew, spores, viruses, dander, and pollen.
 - **Household Products:** Cleaning agents, disinfectants, cosmetic products, paints, and varnishes.
 - **Pesticides or other chemicals.**
- **Ventilation.** Proper ventilation increases fresh airflow within the RV and lowers the concentration of pollutants present. Open doors, windows, and vents to allow fresh air to flow through your RV. Operating fans, air purifiers, and the RV air conditioner(s) or furnace also helps to bring in fresh air and force out stale, polluted air.
- When the RV remains closed, airflow decreases increasing the presence of air pollutants.
- Follow the recommendations within this manual to assist in avoiding exposure to air pollutants and offgassed chemicals.
- **Air Cleaners.** Air cleaners are designed to remove specified pollutants from the air. Their effectiveness depends on how well they are capable of collecting pollutants within their filters. An effective air cleaner requires an intake, proper filters, and a high air circulation return rate. Being that there are many types on the market, it is important to thoroughly research the product. Many smaller, less expensive models are not as efficient with particle removal. Most common air cleaners DO NOT remove gaseous pollutants.

+ NOTICE

Chemical offgassing is a normal process that occurs and is not a defect within your RV. Please follow the recommendations within [Section 4H\(4\)](#). Given that offgassing is normal and to be expected, it is not covered under any warranty provided.

4. Chemical Sensitivity and Offgassing

a. General Information

Upon purchasing a new RV, you may notice a chemical odor due to offgassing. More commonly, you will notice this after the RV has been closed up for a period of time. This is normal, and not a defect. "Offgassing" is the release of gas or chemical vapor that was once trapped, frozen, dissolved, or absorbed within a material. This tends to occur in new RV's and will lessen over time as the materials acclimate and offgas. Like a home, your RV is constructed using materials including, but not limited to linoleum, carpet, insulation, plywood, upholstery, and other common building materials. Being that these materials differ in chemical make-up from one another, it is to be expected they will offgas various chemicals, including formaldehyde. Increased temperatures and humidity will increase the offgassing process. Being that RV's are much smaller than a home, the air exchange within an RV is greatly reduced. Minimal air exchange makes the smell of offgassed chemicals more exaggerated and noticeable.

SEC.04 OCCUPANT SAFETY

+ NOTICE

If not properly ventilated, chemical sensitivity such as eye, nose, and throat irritation along with nausea, headache, or other asthma-like symptoms may occur. Children, the elderly, and/or those with a history of lung-related problems may be more susceptible to the effects of the offgassing process.

b. Formaldehyde

Formaldehyde is a naturally occurring substance that is used widely in building materials such as plywood, pressed wood, paneling, and medium density fiberboard (MDF), all of which are commonly used within the RV construction. Because formaldehyde is contained within some of the materials used within your RV and some people have sensitivity towards the chemical, it is important you properly ventilate your RV as instructed in [Section 4H](#).

c. California Air Resource Board Notice

Formaldehyde is used widely in building materials such as pressed wood products, particleboard, hardwood plywood paneling, medium density fiberboard (MDF), and plywood which are commonly used throughout the Recreational Vehicle Industry. As mandated by the RV Industry, Brinkley RV's contain composite wood products (hardwood plywood, particle board, and MDF) that comply with the California Air Resource Board (CARB) formaldehyde emission standards under California Code of Regulations § 93120.2(a) Phase 2 (P2).



+ NOTICE

Brinkley RV is compliant with the EPA Formaldehyde Standards for Composite Wood Products under Title IV of Toxic Substances Control Act and the California Air Resource Board (CARB) formaldehyde emission standards under California Code of Regulations § 93120.2(a). These can be found at <https://www.epa.gov/formaldehyde/formaldehyde-emission-standards-composite-wood-products> and <https://ww3.arb.ca.gov/research/indoor/formaldehyde.htm>.

5. Condensation and Moisture

a. General

When staying in your RV for extended periods, condensation may occur within your RV if precautions are not properly taken. "Condensation" refers to when vapors found in humid air collect as water. Commonly, this will form in out-of-sight locations such as inside cabinets, closets, on ceiling panels, etc. Not only can condensation cause damage to your RV, it can also damage your personal belongings. When not properly controlled, condensation is often misconstrued as a water leak. To minimize condensation within your RV, proper ventilation should be practiced. The use of a dehumidifier (Customer Supplied) is recommended if proper ventilation is not obtainable or if there is high humidity in the ambient air.

b. Controlling Condensation

To reduce moisture within your RV, please do the following:

- Ventilate the RV as often as possible.
- When bathing, showering, drying hair, etc. within the bathroom, keep the bathroom door closed and open the roof vent with the fan on.
- The exhaust fan should be left on until all excess moisture exits the RV.
- When cooking, keep the microwave or range

exhaust fan on (If Equipped). Cooking releases heat and moisture that may allow condensation to quickly build.

- **DO NOT** hang wet clothes inside your RV to dry.
- Keep a constant source of airflow within your RV to prevent condensation and mildew from forming. (i.e., fan, A/C, air purifier, dehumidifier).
- Keep temperatures cool and constant throughout the RV, including in cabinets, closets, and drawers.
 - While storing your RV, leave cabinets, closet doors and drawers partially open.
 - On an extended stay, periodically open closed off areas such as closets, cabinets, and drawers to allow ventilation.

+ NOTICE

Cabinets, closets, and drawers filled with stored goods and items will prevent circulation and may lead to condensation.

c. Hot Weather Conditions

When traveling in areas of high temperature, start the air conditioner (A/C) early in the day to help remove humidity while lowering the temperature in the RV. This will help prevent condensation and water accumulation leading to possible damage.

d. Cold Weather

During cold weather, utilize your vents and exhaust fans on a continuous basis. This will help to lessen the amount of moisture in the air. Keeping your RV closed up during cold conditions will increase the amount of condensation build-up within your RV. Manage inside temperatures accordingly. As you increase the temperatures within your RV and as the temperatures outside fall, this temperature differential will cause condensation to accumulate in areas that are not insulated as well as others (i.e., windows, vents, wall studs, etc.).

6. If There Is Moisture, There May Be Mold

a. General

“Molds” are microscopic organisms that can virtually live in any environment and under any condition. Mold requires a source of moisture (i.e., high humidity, wet/damp materials, standing water) to thrive and can grow in temperatures between 40° and 100° Fahrenheit (4.44° and 37.78° Celsius respectively). According to the Center for Disease Control (CDC), exposure to damp and moldy environments may cause a variety of health-related concerns:

- For those sensitive to molds, exposure may result in coughing, wheezing, nasal congestion, and/or irritation of the eyes, throat, and/or skin.
- Those allergic to molds or who have compromised immune systems or lung-related conditions may have more severe reactions to exposure.

Mold can be harmful to many materials within your RV, especially natural wood products and fabrics. Please follow the tips below to help control moisture within your RV and the prevention of mold and mildew growth:

- When bathing, showering, drying hair, etc. within the bathroom, keep the bathroom door closed and open the roof vent with the fan on. The exhaust fan should be left on until all excess moisture exits the RV.
- When cooking, keep the microwave or range exhaust fan on (If Equipped). Cooking releases heat and moisture that may allow condensation to quickly build.
- DO NOT hang wet clothes inside your RV to dry.
- Keep a constant source of airflow inside your RV to prevent condensation and mildew from forming. (i.e., fan, A/C, air purifier, dehumidifier).
- Ventilate your RV as often as possible.

SEC. 04 OCCUPANT SAFETY

b. Mold Prevention

To help with the protection against mold within your RV, follow the below preventative measures:

- Regularly clean high traffic areas that have water present including the kitchen, bathroom, and convenience center ([See Section 21M](#) for information on the convenience center). On safe surfaces, mold and mildew cleaning agents are recommended.
- Clean and dry all standing water and spills immediately.
- Remove all damp items within your RV.
- Check sealants regularly. Reseal as needed to avoid water leaks.

I. COLD WEATHER USE

When using your RV near freezing or below freezing temperatures, the following precautions MUST be taken:

- Water sources such as the freshwater and drainage systems require added protection against freezing.
- Sufficient power and propane are required to run your furnace to prevent possible freezing.
- Sufficient fuel for generator use (If Equipped), if camping in remote locations without shore power.
- Proper ventilation should be practiced helping reduce condensation. A dehumidifier (Customer Supplied) may be required if ventilation is not sustainable.
- Prior to operating slide-outs, compartment doors, locks, windows, vents etc., check for ice to avoid possible damage from occurring.

+ NOTICE

Brinkley RV's are not manufactured for sub-zero temperatures.

J. WEBSITES OF INTEREST

We also recommend that you visit the following websites that maintain information about indoor air pollutants, including molds and formaldehyde, along with ways to improve indoor air quality:

- www.epa.gov/indoor-air-quality-iaq/inside-story-guide-indoor-air-quality.
- www.epa.gov/mold
- www.atsdr.cdc.gov

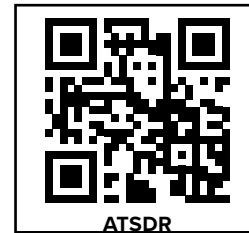

WEBSITE DISCLAIMER OF WARRANTY

Brinkley RV holds no liability whatsoever in connection with the services, information, and/or materials provided within the websites and/or external links noted in this manual. This information is provided "AS IS" and is for informational purposes only. The use of this information provided is at your own risk.

Brinkley RV is not liable for any possible errors, inaccuracies, or omissions that may be present within the information regardless of the delivery of information, decisions made, or actions taken/not taken in reliance to the furnished external information.

Brinkley RV accepts no liability or responsibility whatsoever regarding the information provided on any external source linked or provided within this manual. This information is meant to be taken as general knowledge and not intended to address any specific situation for any given individual or entity.

Brinkley RV has no control over any external links provided and does not hold responsibility if the information is not fully comprehensive, accurate, complete, and/or up-to-date.

Brinkley RV has no liability for any loss and/or injury caused, in whole or part, by the actions, negligence, and or omissions of any contingencies beyond its control for compiling, delivering, or obtaining any information. This information is not to be considered professional nor shall it comprise legal advice.

DISCLAIMER OF ENDORSEMENT

References that may be made within the external or third-party links such as specific commercial products, processes, or goods specific to trademark, manufacturer, or otherwise, shall not be taken as recommended, favored by, as or endorsement by Brinkley RV.

Brinkley RV does not exercise any form of editorial control over the information found within any provided external location. Brinkley RV is not responsible for the content within such external sites and does not warrant, guarantee, or endorse any referenced products, services, information, schools, or goods described or offered within these sources.

K. ADDITIONAL SAFETY PRECAUTIONS

1. Generators

The generators built specifically for RV's should be the only type used within your Brinkley RV. It is important to only operate a generator (If Equipped or Customer Supplied) in an open, outdoor area to permit the exhaust to dissipate. When using a generator, be sure to close all windows, compartments, and entry doors to prevent carbon monoxide from entering your RV. Please refer to [Section 4F](#), for carbon monoxide warnings and additional detail.

+ NOTICE

Generators are not intended to power sensitive electronics without using the appropriate protections such as a line conditioner and surge protectors. Sensitive electronics in need of protection include, but are not limited to, computers, TVs, printers, audio equipment, and video gear. Such electronics should only be operated on inverter-based generators or pure sine wave generators.

2. Loading and Weight Distribution

- **NEVER** surpass the RV's Cargo Carrying Capacity or Gross Vehicle Weight Rating.
- **ALWAYS** distribute the cargo weight evenly throughout the RV.
- **ALWAYS** position heavy items on the floor in the center (closest to the axles) of the RV.
- **ALWAYS** balance weights front-to-rear and side-to-side.

SEC. 04 OCCUPANT SAFETY

3. Passenger Safety

- **NEVER** allow a passenger to ride inside your RV while in motion. This is against the law in many states and for safety reasons should be avoided.

4. Propane Appliances and Equipment

- **ALWAYS** turn **OFF** all propane and gas related appliances and equipment (including tanks) **PRIOR** to transporting your RV.
- **ALWAYS** know and understand all propane and gas related safety warnings and follow all manufacturer recommended operating procedures.

⚠ WARNING

Fuel of any sort is highly flammable. Improper use may result in a fire or explosion leading to property damage, injury, and/or possible death.

5. Tire Pressure

ALWAYS check tire pressures **PRIOR TO** transporting your RV, even for short distances. For proper tire inflation pressures, refer to the Tire Information Label. The Tire Information label is located on the driver side of the unit, in front of the LP compartment, and typically above the Federal ID (VIN) tag. See [Section 5C\(4\)](#).

6. Towing

- **ALWAYS** follow posted speed limits but never exceed 65 miles per hour (104.6 km/h).
- **ALWAYS** respond appropriately to weather and/or road conditions that may impact stability, handling, and towing of your RV and tow vehicle.
- **ALWAYS** be aware of your surroundings.

7. Wheel Torque

- **ALWAYS** check the torque on all lug nuts **PRIOR TO** departing on any trip, including short distances. For lug nut torque specifications and patterns, refer to [Section 5J](#).
- **ALWAYS** use a calibrated torque wrench to confirm torque

⚠ WARNING

RV's can sway and fishtail in high crosswinds or when exposed to external forces created by large vehicles as they pass. If caution is not exercised, control of the RV and tow vehicle can be lost resulting in serious damage, injury, and/ or death. Under such conditions, it is imperative to slow down and pay attention to other vehicles and your surroundings.

A. GENERAL

Traveling can be stressful. To reduce stress, we recommend using updated maps or GPS navigation to ensure your route utilizes the most up-to-date information. Call ahead to obtain tourist information in the areas you will be visiting. To ensure safety, make sure your designated camping area and planned adventures comply with all federal, state, and local rules and regulations.

- While away from your home, have someone you trust periodically check on your residence. If you plan to travel for more than two (2) weeks, consider contacting your local police in advance to keep surveillance of your home.
- Carry secondary keys for vehicles and your house on a separate key ring to prevent them from being lost.
- Ensure your driver's license is updated and valid. Renew your license in advance if it will expire during your travels.
- If you plan on visiting other countries, be sure to contact the border control nearest to your planned point of entry to obtain current entry rules and regulations (including rules for re-entering the United States).

B. TOW VEHICLE DISCLAIMER

Your tow vehicle's Towing Capacity **MUST BE GREATER** than the Gross Vehicle Weight Rating (GVWR) of your RV. If you do not know your Towing Capacity or if you are considering purchasing a new tow vehicle, contact your automotive manufacturer or Dealer to obtain the towing specifications of the prospective vehicle(s).

Be aware that some vehicles can be purchased with optional towing packages.

Some automotive manufacturers have brochures for their products that contain towing capabilities and specifications. This information should be reviewed to verify weight ratings and limitations. Make sure you are looking at your exact model, year, engine, transmission, etc., to ensure you are receiving accurate information.

+ NOTICE

Brinkley RV shall not be liable for any damages that may be incurred by the Customer, owner, or driver of a Brinkley RV as a result of the operation, use, and/or misuse of a tow vehicle.

C. VEHICLE LABELS

Throughout your RV, labels and data plates are present containing information pertaining to safe operation, service instructions, RV specifications, and warnings. Be sure to read all provided labels, decals, and data plates before operating your RV. If any label within your RV is damaged, painted over, or removed, they should be replaced right away.

1. Weight Ratings and Definitions

It is vital to remain within the weight rating specifications of your RV and tow vehicle. Failure to do so may result in loss of warranty, damage to your tow vehicle, or damage to your RV. More critically, failure to adhere to weight limitations poses great danger to you and those around you when operating or towing your RV. Vehicle and RV weights fall into two categories:

- **Ratings** are maximum limit thresholds that should **NEVER** be exceeded. These limits are established by Brinkley RV and our component manufacturers in the design of the RV.

SEC. 05 PRE-TRAVEL INFORMATION

- **Weight and Load** are often used interchangeably and refer to the actual weight of the RV. Weight or Load is measured by placing an RV, tow vehicle, or its components on a scale. Vehicles and added cargo add weight and affect the distribution of weight to the hitch, tires, and axles.

⚠ WARNING

Exceeding a rating may result in unsafe conditions, potential damage, may void warranty, may complicate an insurance claim, and in some cases, may violate applicable law.

⚠ WARNING

The volume of space available for storage may exceed the amount of available Cargo Capacity. Large storage compartments have been designed to accommodate normal camping items, which are bulky, but not necessarily heavy.

⚠ WARNING

The actual total weight of the RV, its options, holding tanks and contents, personal cargo, and hitch weight are important to know so that you **DO NOT** exceed the Gross Vehicle Weight Rating (GVWR) of the RV.

To better understand how to safely manage your RV's weight and balance, please see the weight-related definitions outlined below:

Gross Axle Weight Rating (GAWR)

Gross Axle Weight Rating (GAWR) is the maximum weight the axles are designed to carry.

Gross Vehicle Weight Rating (GVWR)

Gross Vehicle Weight Rating (GVWR) (also known as Maximum Load Capacity) equals the GAWR plus the hitch weight. GVWR is the maximum allowed weight your trailer is rated to carry. This weight includes the weight of the trailer itself and ANY cargo or equipment you intend to haul inside the RV.

Gross Vehicle/Trailer Weight (GVW or GW)

Gross Vehicle Weight (GVW) is the actual weight of the RV, including everything in or on the RV, and is established by measuring on a scale. This is the actual weight of the trailer fully loaded.

Gross Combined Weight Rating (GCWR)

The Gross Combined Weight Rating (GCWR) is the maximum allowable weight of a fully loaded tow vehicle and the weight of the fully loaded RV combined.

Gross Combined Weight (GCW)

Gross Combined Weight (GCW) is the actual weight of your fully loaded RV and tow vehicle combined, as measured on a scale.

Unloaded Vehicle Weight (UVW) (or Dry Weight)

Unloaded Vehicle Weight (UVW) or Dry Weight is the weight of the RV as it is built from the factory with no added water, fuel, propane, supplies, or passengers. This includes only the items installed at the factory and no aftermarket installations made by you, the Dealer, or any other entity.

Hitch Weight (HW) (or Tongue Weight)

Hitch Weight (HW) or Tongue Weight is the actual amount of weight that presses down on the hitch when the RV is connected to the towing vehicle.

Cargo Carrying Capacity (CCC)

Cargo Carrying Capacity (CCC) is the maximum weight of personal cargo that can be added to the RV.

- **In the United States:** $CCC = GVWR - [UVW \text{ and LP gas weight}]$. Water is a component of the CCC.
- **In Canada:** $CCC = GVWR - [UVW, \text{LP gas weight, and full fresh (or potable) water weight (including the water heater)}]$. Water weight is not a component of the CCC.

2. Weight Labels

Vehicle weight labels are placed on every RV to ensure the owner and/or potential buyer is fully aware of this information. Proper weights and limitations are important to the use of your RV.

+ NOTICE

Do not remove these labels. If the labels are missing or damaged contact your Dealer or Brinkley RV Customer Care for replacement decals.

3. Federal Certification Label

The Federal Certification Label specifies the maximum capacities for GVWR, GAWR, and the tires. This is located on the driver's side (also known as the off door side) towards the front of your RV. Typically, this label is located in front of the LP compartment. Below is an example of the Federal Certification Label. Note that the information on your specific RV on this tag will vary from what is shown below:

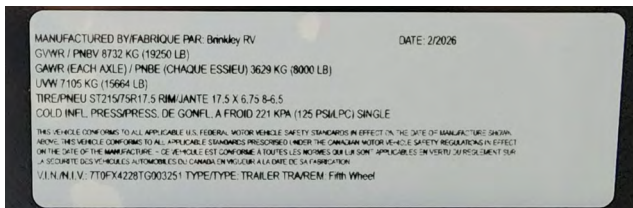

4. Tire and Loading Information Label

The Tire and Loading Information Label provides tire size information, recommended tire pressure(s), and the maximum amount of cargo that can be safely added to the RV. This label is located on the driver's side (also known as the off door side) towards the front of your RV. Typically, this label is located in front of the LP compartment. Below is an example of what the Tire and Loading Information looks like. The information contained on this tag may vary on your RV from what is shown below:

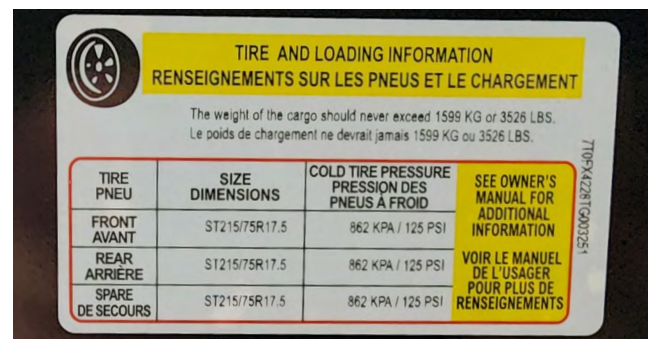

5. Cargo Carrying Capacity (CCC) Label

The Cargo Carrying Capacity Label specifies the maximum cargo carrying capacity for your RV. It is located on the outside of your RV on the edge of the main entry door.

An example label is provided below:



SEC.05 PRE-TRAVEL INFORMATION

6. RV Length

a. Travel Trailers

The length of the RV is measured from the tip of the hitch coupler to the end of the rear most extremity of the RV.

b. Fifth Wheel Trailers

The length of the RV is measured from the most extreme front profile, commonly the tip of the pin box, to the end of the rear most extremity of the RV.

c. RV Overall Length Exclusions

The overall length of your RV excludes select accessories as defined by Brinkley RV, including but not limited to the following:

- Safety-related equipment such as signals, clearing, indication, and warning lights.
- Appliance vent and vent hoods.
- Door latches and hinges.
- Entry and exit handles, grab bars, and/or railings.
- Exterior installed ladders.
- Spare tires, tire brackets, and/or carriers.
- Rear bumper.
- Outdoor cooking appliances.
- Towing hitch or cargo accessory receivers.
- Equipment or racks utilized to secure cargo.

D. CARGO CAPACITIES AND WEIGHTS

When loading your RV with cargo, **DO NOT** exceed any of the following:

- The maximum Cargo Carrying Capacity (CCC) noted on the Federal Tag.
- The Gross Vehicle Weight Rating (GVWR).
- The Maximum Load Rating of your RV tires.

⚠ WARNING

The load capacity of your RV is designated by weight, not by volume. All available storage space cannot necessarily be used when loading the RV. For the best possible handling:

- **DO NOT** exceed your GVWR.
- Ensure you are loading the vehicle evenly.
- Secure all loose or heavy items to prevent shifting during travel.

1. Maximum Load Rating

The Maximum Load Rating of your RV tires may be less than the GVWR. To calculate the load on your RV tires, subtract the hitch weight from the RV's Gross Weight or Total Weight. The hitch weight is carried by your tow vehicle, NOT the RV tires. Therefore, the hitch weight is subtracted.

EXAMPLE CALCULATION:

- Each RV tire is rated at 4,800 lbs. (2,177 kg), and there are 4 tires. 4 tires x 4,800 lbs. = 19,200 lbs. (8,709 kg).
- The Gross Vehicle Weight of the RV is 15,000 lbs. (6804 kg) with a hitch weight of 1,300 lbs. (590 kg): 15,000 lbs. (6804 kg) – 1,300 lbs. (590 kg) = 13,700 lbs. (6,214 kg) to be carried by the tires.
- In this example, the load distributed on the RV tires is 13,700 lbs. (6,214 kg) This is below the 19,200 lb. (8,709 kg) maximum tire load rating in the example
- This figure should **ALWAYS** be under the maximum load rating of the tires. If it is not, you must remove weight from the RV to reduce the load on the tires below the maximum tire load rating.

2. Water and Propane (US ONLY)

- Fresh water is to be calculated as part of the Cargo Carrying Capacity Weight.
 - Water weighs approximately 8.3 lbs. per gallon (1.0 kg per liter).
 - Based on this weight per gallon, a 50-gallon (189.3 liters) tank full of water will weigh roughly 417 lbs. (189.2 kg).

When nearing GVWR, try reducing the amount of water in the holding tank to lessen the water weight and to increase the amount of weight available for additional cargo needs. This will provide additional flexibility when making choices to match your travel and camping needs without compromising safety.

ALWAYS REMEMBER:

- The Unloaded Vehicle Weight (UVW) is calculated with empty LP bottles, holding tanks, and as built at the factory. Modifications are not included in the calculation.
- In the United States, Cargo Carrying Capacity is calculated including the weight of full LP bottles. $CCC = GVWR - (UVW + LP \text{ gas weight})$. Water is considered part of the cargo weight.
- In Canada, Cargo Carrying Capacity is calculated including the weight of full LP bottles and full freshwater tanks, including the water heater. $CCC = GVWR - [UVW + LP \text{ gas Weight} + \text{full fresh/potable water tanks (including the water heater)}]$.

For further questions, please contact your Dealer or Brinkley RV Customer Care.

3. Loading Your RV

When loading your trailer, it is critical that you understand the weight limitations of your RV and tow vehicle as well as the importance of maintaining a balanced load from side-to-side of the RV. Section 5D(4) below covers the weighing process in detail to help ensure that you properly load your RV prior to travel.

WARNING

ONLY store items in the areas designated for storage. **DO NOT** store anything in the areas reserved for the furnace, water heater, converter, electrical panels, and other appliances.

WARNING

During a sudden stop, free-standing furniture or overlooked items on the counter tops or shelves can become dangerous projectiles. It is important to secure the appliance or furniture with tie-down straps (If Equipped or Customer Supplied). Be sure to store and secure all loose items inside your RV. Check that all items are safely put away **BEFORE** travel.

4. Weighing the Tow Vehicle and RV

a. In General

Total weight and **balance** of the RV are the two most important factors when loading your RV. It is important to **ALWAYS** follow and never exceed the weight rating limits specified for your RV. To ensure you are not exceeding your Gross Vehicle Weight Rating (GVWR) and other weight limitations, you should weigh your RV at a public scale or weigh station once your RV is fully loaded.

SEC.05 PRE-TRAVEL INFORMATION

Utilizing a scale will also help to determine proper load distribution. To better ensure you are balancing load within your RV, it is best to use a weigh station that has separate scales to weigh the driver and passenger sides of the RV.

+ NOTICE

Individual scales and weigh stations may operate differently. If you have any questions or concerns, do not hesitate to contact us.

It is our priority to ensure you have the tools necessary to safely tow your RV.

b. Weighing Your Tow Vehicle and RV

It is important to read and understand the weighing instructions prior to attempting to weigh your RV. Understanding this information is vital to ensure your safety. When weighing your RV, it must be weighed fully loaded with all contents you intend to travel with (i.e., food, water, clothing, supplies, propane, fuel, etc.) to obtain an accurate measurement and to determine whether you are within the weight limitations provided.

⚠ WARNING

An RV that is overloaded or has an imbalanced load will adversely affect your tow vehicle's handling and braking capabilities. It can also lead to component failures that could leave you stranded on the side of the road. Overloading can affect your safety and the safety of those around you. It will also lead to voiding of any applicable warranties as overloading is considered a form of misuse.

⚠ WARNING

DO NOT EXCEED YOUR GVWR!

You should weigh the RV as loaded for your normal travel to determine the actual weight. If you exceed the GVWR, you **MUST** remove items from the RV, or drain liquids, then reweigh the RV to ensure you have achieved a safe weight below the stated GVWR. Also, **DO NOT** travel with full gray/black holding tanks as doing so negatively impacts fuel efficiencies and the towing and handling characteristics. It is also recommended that you **NOT** travel with a full fresh tank. You should plan to fill the fresh tank as close to your end destination as possible.

⚠ WARNING

NEVER load the RV more than the GAWR for either axle. Overloading the RV may result in adverse handling characteristics and damage to the RV chassis. Evenly distribute your cargo side-to-side for safe travel. The weight on each tire must not exceed one-half of the GAWR (Gross Axle Weight Rating) for either axle.

⚠ WARNING

Exceeding the established weight ratings for the axles, running gear, tires and wheels can lead to failure that can affect motor vehicle safety and lead to property damage or damage to the RV.

PROPER WEIGHING PROCEDURE:

1. GROSS VEHICLE WEIGHT CALCULATION

Weigh your RV while unhitched from the tow vehicle to obtain your Gross Vehicle Weight (GVW). Be sure to pull the tow vehicle far enough away such that it is not included in the weight calculation. You will also have to lower the landing gear (fifth wheel) or tongue jack (travel trailer) to obtain the weight measurement.

- For safe operation, your Brinkley RV's Gross Vehicle Weight (GVW) **MUST** be less than or equal to the Gross Vehicle Weight Rating (GVWR).
- If your Brinkley RV's GVW is greater than the GVWR, you **MUST** remove contents until the GVW is less than your Brinkley RV's listed weight ratings.

2. GROSS COMBINED WEIGHT CALCULATION

Hitch your RV to the tow vehicle. Weigh the RV and tow vehicle to obtain your Gross Combined Weight (GCW).

- Confirm that your GCW is less than, or equal to the GCWR specified by the manufacturer of your tow vehicle.
- If your GCW is greater than the GCWR, remove contents until the weight is less than the GCWR.

3. HITCH WEIGHT CALCULATION

While still hitched to the tow vehicle, pull onto the scale to weigh only the RV, and record that weight. This measures the total load carried by the RV tires. This weight, when subtracted from the GVW, is your Hitch Weight.

4. BALANCED WEIGHT CALCULATIONS

To obtain the side-to-side weights of the RV, there must be ample room on either side of the scale to accommodate the RV being partially off the scale.

- Pull the RV so that the tires of only one side of the RV are on the scale. Your RV must remain as level as possible in order to obtain an accurate weight measurement.
- **For a balanced load:** The weight of one side of your RV, must be equal to one half (1/2) of the total weight on the tires that you measured in step 3 above. If this is not the case, then you must redistribute the load until the RV is equally balanced side-to-side.

If you have questions or concerns, please consult with your Dealer, scale operator, or Brinkley Customer Care for additional assistance.

WARNING

The total weight of your tow vehicle and RV must not exceed the GCWR. **NEVER** assume that you can tow an RV that happens to be within the capacity of the tow vehicle hitch. By doing so, you may exceed the total GCWR.

WARNING

It is important to redistribute the load to avoid component failure as well as to improve the handling characteristics of the vehicle. When a load is unbalanced, the components located on the heavier side of the RV (the wheels, brakes, springs, axle hangers, tires, etc.) may be overloaded, even though the total axle load is within the limits imposed by the GAWR.

SEC.05 PRE-TRAVEL INFORMATION

E. TIRE SAFETY INFORMATION

1. Introduction

This section of the Owner's Manual contains tire safety information as required by 49 CFR 575.6(4) and is based in part on the National Highway Traffic Safety Administration's (NHTSA) brochure entitled "Tire Safety, Everything Rides On It." Click the link or scan the QR code below.



[NHTSA Tire Safety Brochure](#)

Tire safety studies show that the most important things you can do to avoid tire failure, blowouts and flat tires are as follows:

- **ALWAYS** maintain proper tire pressures.
- **OBSERVE** and adhere to tire and vehicle Load Limits.
- **NEVER** carry more weight in your vehicle than your tires or vehicle can safely handle.
- **AVOID** road hazards.
- **DRIVE** within the designated tire speed ratings.
- **INSPECT** tires for slashes, cuts, marks, and other irregularities.

These actions, along with other care and maintenance activities, can also:

- Improve vehicle handling.
- Improve stopping distance.
- Increase traction.
- Improve overall fuel economy.
- Help protect you and others from avoidable and/or preventable breakdowns and accidents.
- Increase the life of your tires.

Make tire safety a regular part of your vehicle maintenance routine. Know that the time you spend on tire safety and maintenance is minimal compared to the inconvenience and safety consequences of a flat tire or other tire failure.

2. Maximum Load Rating

The Maximum Load Rating indicates the maximum load in pounds (or kilograms) that can be safely carried by the tire.

3. Maximum Inflation Pressure

The Maximum Permissible Inflation Pressure is the greatest amount of air pressure that the tire should ever be inflated to under normal driving conditions.

⚠ WARNING

Under-inflated tires and overloaded vehicles are major causes of tire failure.

4. Tire Pressure and Load Limits

Tire information placards and vehicle certification labels provide important information regarding tires, weights, and load limits, including the following:

- The recommended tire size.
- The recommended tire inflation pressure.
- The Cargo Carrying Capacity (CCC).
- The front and rear Gross Axle Weight Ratings (GAWR).

For definitions and information regarding labels See Section 5C.

Load Limits are determined by the tire size and the maximum amount of weight each tire can safely carry.

Tire Pressure is the amount of air pressure a tire requires to achieve proper inflation. It is measured in pounds per square inch (psi) or kilopascals (kPa). Tire pressure affects your RV's overall performance and provides the load-carrying capacity.

On the Tire and Loading Information Label, the proper tire pressure for your vehicle is listed as Cold Tire Pressure. You will find this number expressed in both psi and kPa.

⚠ WARNING

Always check tire pressure when tires are cold. Cold tire inflation pressure is defined as a tire that has not been used for three (3) or more hours or has been driven less than one mile (1.6 Kilometers) prior to the pressure measurement. Note that a hot tire may increase the tire inflation pressure by as much as six (6) psi (41.4 kPa) over a cold tire. **DO NOT** exceed the maximum recommended pressure.

+ NOTICE

The axle and wheel assemblies on your RV are designed and manufactured much differently than that of an automobile. The overall size, weight, and balance of your RV exposes the wheels to pressures that are unique to trailering. When turning, or cornering, the wheels and tires experience a considerable amount of stress known as “side loading.”

5. Checking Tire Pressure

a. Frequency

It is important to check the cold inflation pressure of your RV’s tires at least monthly since: Most tires will lose air pressure naturally over time, particularly when the outdoor temperatures fluctuate.

Tires can suddenly lose air after driving over a pothole, hitting road debris, or striking a curb. With radial tires, it is generally not possible to visually determine if a tire is under-inflated.

+ NOTICE

For safety and convenience, you should always keep a Tire Pressure Gauge in your vehicle.

b. Maintaining Proper Tire Pressure

TIRE PRESSURE:

1. The recommended cold inflation pressure is listed on the Tire and Loading Information label located on the exterior of your RV, on the off door side, forward of the LP compartment. You should first locate this label to ensure that you know the recommended cold inflation pressure of each tire.
2. Use a Tire Pressure Gauge (Customer Supplied), to check the tire pressure of every tire:
 - If the tire pressure is above the maximum inflation pressure in any of the tires, gently press on the tire valve stem release valve with the edge of your tire gauge. Slowly release air until the correct pressure is obtained.
 - If the tire pressure is below the recommended cold inflation pressure in any of the tires, immediately add air to any underinflated tires.
3. At a service station or otherwise utilizing an air compressor, add air to each under-inflated tire until the correct cold inflation pressure is reached. **DO NOT OVER-INFLATE.**
4. Re-check the RV tires with the Tire Pressure Gauge. Confirm that all tires are at the same recommended cold inflation pressure. Make any additional adjustments as needed.

SEC.05 PRE-TRAVEL INFORMATION

⚠️ WARNING

If the total weight of the RV (GVW) exceeds the GVWR, the RV is overloaded. Operating your RV while exceeding the specified weight ratings increases the risk of a crash, personal injury and death. It is imperative that you remove cargo (equipment, water, personal belongings, etc.) until the total weight of the RV no longer exceeds the GVWR before operating the RV.

⚠️ WARNING

Although it is ideal to check and fill tire pressures when the tires are cold, if you discover a tire on your RV that is underinflated, even if the tires are warm, add air until the recommended cold inflation pressure is reached. The warm tire may remain slightly underinflated, but this is much safer than driving with a significantly underinflated tire. REMEMBER to recheck and adjust the tire pressure(s) as soon as a cold tire pressure reading can be obtained to ensure proper inflation.

6. Overloading Your RV and Tires

Overloading your RV and/or tow vehicle's suspension system can cause spring, axle, shock, chassis damage and/or brake failures. Overloading your RV can increase stopping distances, create handling and/or steering problems or difficulties, cause irregular tire wear, blow-outs, tire failure, and/or other damage to the RV and/or tow vehicle.

In cases of excessive overloading, RV brakes are at risk of failing completely, particularly on steep declines when the weight of the RV applies additional stress to the brake system.

Tire overloading caused by exceeding Cargo Carrying Capacity and/or improper inflation of tires may result in abnormal flexing, wear, and tear of the tire. Abnormal tire flexing can cause an excessive amount of heat to generate within the tire. This should be avoided at all costs. Failure to do so may result in fire and/or damage to tire assembly and/or RV.

⚠️ DANGER

EXCESSIVE HEAT MAY LEAD TO TIRE FAILURE. PROPER INFLATION IS CRITICAL. It is the air pressure that enables a tire to support the load.

⚠️ DANGER

Overloading your RV can have serious consequences for passenger safety. An overloaded vehicle is generally harder to drive and more difficult to stop. Excessive overloading may also cause brakes to fail completely.

⚠️ DANGER

If the weight on the trailer axles exceeds the GAWR, the axles are overloaded. Operating your RV while exceeding the specified weight ratings increases the risk of a crash, personal injury, and death. It is imperative that you remove or rearrange cargo (equipment, personal belongings, water, etc.) until the axle weight no longer exceeds the GAWR before operating the unit. Not operating your RV within the designed weight ratings can damage your RV and can void the warranties.

7. Proper Tire Load Limits

Tire size, load range, and corresponding inflation pressure all determine the load a tire can safely carry. The required air pressure for RV tires must be determined by the actual load of the RV and taken from the Load and Inflation Tables provided on the tire manufacturer's website (See [Section 5D\(4\)](#) for weighing instructions).

- The air pressures recommended on tire manufacturing websites may differ from those provided on the certification label of your RV.
- RV weight and/or tire pressure should never exceed the tire's stated Maximum Load Rating or maximum air pressure.
- If you discover that your tires cannot support your RV's weight, REMOVE enough cargo until the RV's weight is within the stated limits.

To determine the correct cargo load limit:

- Locate the statement "The weight of cargo should **never exceed** XXX KG or XXX LBS" on your RV's Cargo Carrying Capacity label. See Section 5C(5) for information on the CCC label.
- The Cargo Carrying Capacity is the available load capacity for cargo and luggage (See Section 5 above for full details and definitions). The combined weight of cargo and luggage loaded on your RV must not exceed the Cargo Carrying Capacity.

8. Tire Safety Tips

- **DO NOT** run over curbs, potholes or foreign objects in roadways, campsites, or when parking.
- **SLOW WAY DOWN** if you cannot avoid a pothole, animal, or any other object in the road.

TIRE SAFETY CHECKLIST:

1. **CHECK** all tire pressures prior to every trip, including any spare tires.
2. **INSPECT** all tires for uneven wear patterns, cracks, foreign objects, or any other damage.
3. **Carefully REMOVE** bits of glass or foreign objects wedge in the tread.
4. **CHECK** that the valve caps are on the tire valve stems.
5. **CHECK** the wheel torque prior to each trip. See [Section 5J](#).
6. **DO NOT** overload your vehicle.

+ NOTICE

FOLLOW the instructions for cargo and cold tire pressure found on your Tire and Loading Information label.

9. Tire Labeling

Federal law requires that tire manufacturers provide standardized information molded into the sidewall of all tires sold in the United States. This information includes:

- Tire size.
- Construction.
- Various capacities (maximum pressure, load, speed).
- Tire Identification Number.

SEC.05 PRE-TRAVEL INFORMATION

US DOT TIRE IDENTIFICATION NUMBER (TIN):

The Tire Identification Number is provided for safety standard certification and in the event of a recall. This identification is considered the tire's serial number and provides specific production details to the tire.

- The TIN begins with "DOT" and is usually followed by 10-12 numbers, letters, and symbols.
- The first two (2) numbers or letters following DOT, signify the plant in which the tire was manufactured.
- The last four (4) numbers signify the week and year the tire was built (i.e., 2123 = the 21st week of 2023).
- The remaining characters in the TIN are codes used at the tire manufacturer's discretion and vary by supplier.

10. Tire Size and Type Designation

The tire specifications are located on the Tire and Loading Information label or on the sidewall of the tire that you are replacing. As an example, the tires on your RV at the time of publication of this Owner's Manual are marked with a designation of:

Coding Break Down

- The first three (3) digit number (215 in the example above) provides the tire width in millimeters measured from sidewall edge to sidewall edge.
- The next two (2) digit number after the "slash" mark (75 in the example above), provides the tire height-to-width ratio of the tire. This is also referred to as the aspect ratio.
- The "R" stands for radial.
- The last three (3) digit numbers (17.5 in the example above) is the diameter in inches of the wheel.
- Finally, "HRT" means that the tire is H-rated. The rating dictates the maximum speed of the tire. In this case, the maximum speed for an H rated RV tire is 75 miles per hour (mph) (120 kilometers per hour (kph)).

DO NOT exceed the Speed Rating regardless of the posted maximum speed limit.

For further information, please contact a tire Dealer, Brinkley RV Customer Service, or refer to the full tire sidewall diagram referred to the right.



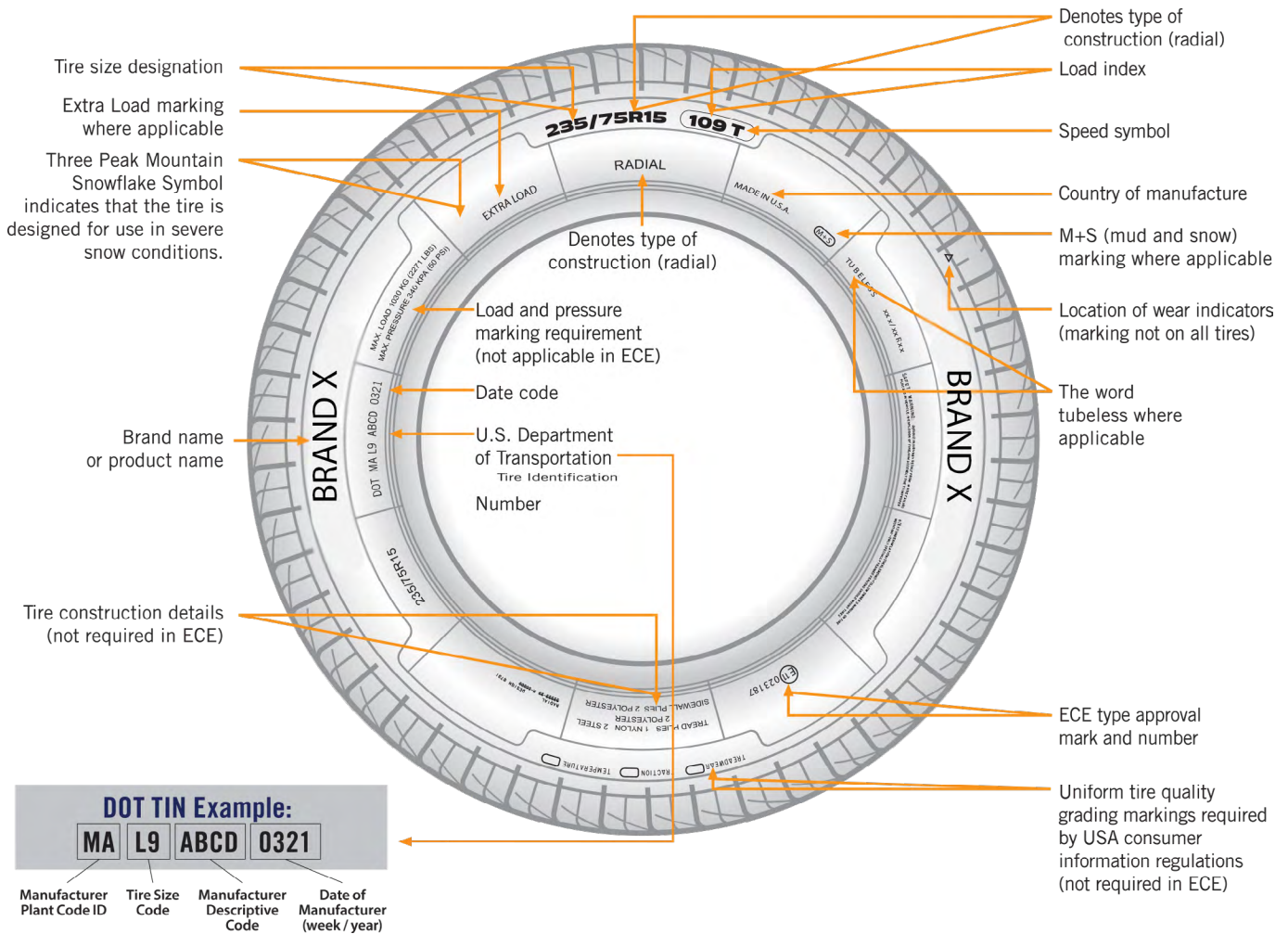

F. TIRE TREAD

The tread of the tires is what provides frictional force, water evacuation, and traction that prevents your RV and vehicle from slipping and sliding. The frictional force also assists in slowing the RV or vehicle down within acceptable stopping distances. This is particularly important when the road conditions are wet, snowy or ice covered. Tires with 1/16" or less tread depth are not safe and should be replaced.

Tread wear beads are raised sections built into the bottom of a tire's treads to show how much tread remains.







When your tread wear beads appear to be even with the outside of the tread, it is an indicator that it is time to replace your tires. There are also gauges utilized by service centers to measure the remaining tread depth. Please refer to the picture shown below and right for additional detail.

Inspect your tires regularly for uneven tread wear. Uneven tire wear is an indication of imbalanced loads, over or under-inflated tires, wheel balance, or other misalignments. The sooner the cause of the uneven tread wear is remedied, the better. Replacing tires can be an expensive endeavor.

SEC.05 PRE-TRAVEL INFORMATION

For your ease of reference, the table below shows the various forms of uneven tire wear and their likely cause.

TIRE WEAR DIAGNOSTIC CHART

WEAR PATTERN		CAUSE	ACTION
	CENTER WEAR	OVER INFLATION	ADJUST PRESSURE TO PARTICULAR LOAD PER TIRE CATALOG.
	EDGE WEAR	UNDER INFLATION	ADJUST PRESSURE TO PARTICULAR LOAD PER TIRE CATALOG.
	SIDE WEAR	LOSS OF CHAMBER OR OVERLOADING	MAKE SURE LOAD DOESN'T EXCEED AXLE RATING . ALIGN AT ALIGNMENT SHOP.
	TOE WEAR	INCORRECT TOE-IN	ALIGN AT ALIGNMENT SHOP.
	CUPPING	OUT-OF-BALANCE	CHECK BEARING ADJUSTMENTS AND BALANCE TIRES.
	FLAT SPOTS	WHEEL LOCKUP & TIRE SKIDDING	AVOID SUDDEN STOPS WHEN POSSIBLE AND ADJUST BRAKES.

G. TIRE PLY COMPOSITION AND MATERIALS

Tires are constructed from multiple layers of rubber coated fabrics. Each layer is referred to as a ply. In general, the higher the number of plies in a tire, the more weight it can support. Tire manufacturers must report all materials used in the composition of their tires, (steel, nylon, polyester, etc.).

H. SPARE TIRE

The spare tire is utilized for instances where an RV tire is damaged, flat, or otherwise fails to maintain air pressure.

The spare tire is secured below your RV. Locate the 1" (2.54 cm) access hole in the skirt metal on the door-side of your RV, approximately even with the spare tire. The photo below shows the location of the 1" access hole.

NOTE: The spare tire does not include a Tire Pressure Monitor Sensor.

⚠ WARNING

The spare tire and wheel may differ from the original equipment. The spare tire is only intended for temporary use. Please refer to the tire specifications on the sidewall of the spare tire for additional information and to ensure your safety.

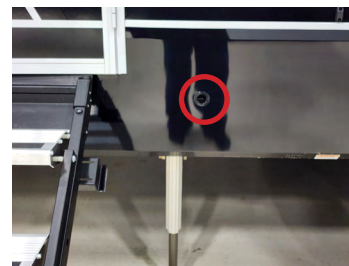

- Insert the crank handle extension.
- Turn the crank handle counterclockwise to lower the spare tire.
- Turn the crank handle clockwise to raise the spare tire.

I. TIRE CHANGING BASICS

Use a hydraulic jack and jack stands (both items Customer Supplied) when changing a tire. Below are general instructions on changing an RV tire.

CHANGING THE TIRE:

1. Before beginning, block the wheels on the opposing side of the tire in need of being changed. This will prevent accidental movement while changing the tire and is vital to ensure safety.
2. Before lifting the RV with a hydraulic jack (Customer Supplied), loosen the wheel lugs on the tire.
3. Place the hydraulic jack on the I-beam of the RV frame and close to the spring hanger. Slowly lift the RV until the tire is hovering an inch (2.54 cm) or two (5.08 cm) above the ground.
4. Place a jack stand under the RV frame just behind the tire being changed. The jack stand serves as a safety measure to prevent the RV from falling if the hydraulic jack moves or fails to hold the weight of the RV.
5. Once fully stabilized, continue with changing the tire and follow the wheel nut torque specifications and wheel.

⚠ WARNING

NEVER use a stabilizer jack or the leveling system to lift the RV. The stabilizer and leveling jacks are not intended to lift the unit off the ground. Utilizing these jacks to change a tire could result in injury, property damage, voiding a warranty, or death.

⚠ WARNING

Before you climb or crawl underneath the RV, both the front and rear axles should be supported with jack stands. Failure to do so may result in serious injury, property damage, or death.

J. WHEEL NUT TORQUE

The torque of the wheel lug nuts must be maintained and inspected on a continuous basis. Torque measures the tightness of a lug nut or the rotational force and is measured in foot-pounds (ft-lbs.) or Newton meters (Nm). When checking torque, please see the following instructions.

- **ALWAYS** properly calibrate the torque wrench prior to use.
- **NEVER** use a torque wrench that is worn out or damaged.
- **ALWAYS** check every lug nut's torque prior to departure. Regardless of how short the trip may be, proper lug nut torque is imperative to ensure your safety.
- **DO NOT** under or over-torque any lug nut. Under and over-torque can be dangerous and may cause damage or failure.
- **ALWAYS** tighten lug nuts with the correct lug pattern shown in the diagram below.

Tire Installation:

Once the wheel and tire are removed, and the wheel and tire assembly are mounted, start by hand tightening all lug nuts until snug and then tighten per the torque sequence indicated in the diagram below.

- **1st Stage**—Tighten all lugs to 20-25 ft. lbs. of torque.
- **2nd Stage**—Tighten to 50% of the final torque specification.
- **3rd Stage**—Tighten to stated final torque specification.

TORQUE SEQUENCE

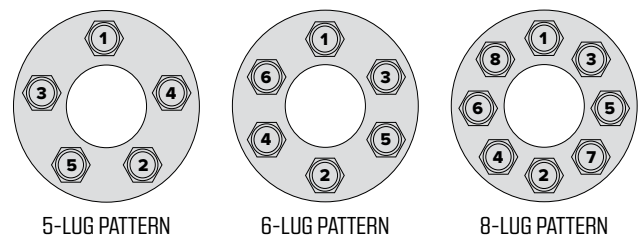

SEC.05 PRE-TRAVEL INFORMATION

Determine the correct torque and torque sequence for each stage and use the Final Torque Specification Table shown below.

WHEEL TORQUE SPECIFICATION TABLE

STUD SIZE	LUG NUT TYPE	FINAL TORQUE SPECIFICATIONS	WHEEL SIZE	WHEEL MATERIAL
1/2"	CONED	90-120 FT. LBS. (122-162.7 NM)	14"/15"/16"	STEEL
9/16"	CONED	20-140 FT. LBS. (162.7-189.8 NM)	16"	STEEL
1/2"	CONED	90-100 FT. LBS. (122-135.6 NM)	14"/15"/16"	ALUMINUM
9/16"	CONED	120-140 FT. LBS. (162.7-189.8 NM)	16"	ALUMINUM
9/16"	CONED	120-140 FT. LBS. (162.7-189.8 NM)	17.5"	ALUMINUM

⚠ WARNING

Always torque the wheel lug nuts to the specifications provided by the wheel manufacturer. Over and under-torqued wheel lug nuts can cause the wheel to separate from the mounting surface during transport, causing property damage, personal injury, or death.

+ NOTICE

Lug nuts on the RV wheels require frequent torque maintenance. Torque measures the tightness of a lug nut or the rotational force and is measured foot-pounds (ft-lbs.) or Newton meters (Nm).

K. TIRE WARRANTY

Tires are warranted by the Tire Manufacturer, not by Brinkley RV directly. If you require tire warranty assistance, please refer to the tire warranty information provided in the Owner Information Package and in Section 4 of the provided Warranty Guide. Note that you can always contact your selling Dealer or Brinkley Customer Care for further assistance.

L. ROADSIDE EMERGENCY

A roadside emergency can occur at any given time. ALWAYS carry an emergency travel kit (Customer Supplied) with three red warning flags, flares, or cones to display if necessary. In case of an emergency roadside stop:

- Pull off the side of the road as far as possible ensuring you are away from traffic.
- Turn ON the vehicle and trailer hazard lights to alert other drivers to pass with caution.
- Place the three (3) warning indicators (flares, signs, flags, reflectors, cones, lanterns, etc.) as follows:
 - **1st indicator:** 10 feet (3.05 m) behind the RV driver's side also referred to as off door side.
 - **2nd indicator:** 100 feet (30.5 m) behind the RV in the center of the lane in which you are in.
 - **3rd indicator:** 200 feet (60.7 m) behind the RV in the center of the lane in which you are in.
- Address the emergency promptly and as cautiously as possible.

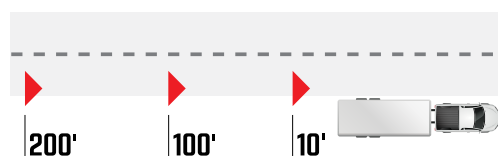

+ NOTICE

Curves and/or elevation changes in the roadway may affect the safe placement of warning indicators. Please plan to make adjustments to their placement as necessary. The purpose of the warning indicators is to provide a warning to others and for your own safety.

Display and Components



NOTE: INTERNAL SENSORS ARE MOUNTED INSIDE THE TIRE/WHEEL ASSEMBLY, NECESSITATING TIRE REMOVAL FOR INSTALLATION

A. GENERAL INFORMATION

Your RV is equipped with a Truck System Technologies® (TST) Banded Tire Pressure Monitoring System (TPMS). These banded sensors are mounted on the wheel at the factory and are located 180 degrees from the valve stem.
NOTE: The spare tire does not include a sensor.

The purpose of a tire pressure monitoring system (TPMS) is to warn you of any issues that may create unsafe driving conditions. These conditions may include overinflation, underinflation, or overheating of the tire(s). TST TPMS offers real time pressure and temperature readings as you are traveling with your RV. Prior to the RV leaving the factory, the TPMS sensors are programmed and the monitor is ready for use upon purchase of your RV.

NOTE: PARAMETER SETTINGS FROM FACTORY ARE THE BELOW:

- Pressure Unit: psi (kPa)
- High Pressure Alarm: 175 psi (1206.5 kPa).
- Low Pressure Alarm: 100 psi (689.4 kPa).
- Temperature Unit: ° F (° C).
- High Temperature Alarm: 158° F (70° C).

For troubleshooting, reprogramming, or other miscellaneous information on your TST TPMS, please scan the QR Code below or click the link to visit the TST TPMS Product Support Page.



[TST 770 TPMS User Manual](#)

SEC.07 TOWING & HITCHING

A. RECOMMENDED SAFETY

To improve safety and to help protect against injury, follow the below recommendations:

- **ALWAYS** keep tires properly inflated and replace worn tires as needed on the RV and tow vehicle. Do not wait until they are excessively worn.
- **ALWAYS** obey all traffic laws and wear your seatbelt.
- **DO NOT** exceed the posted roadway speed limit.
- Follow lowered speed limits for tow vehicle and RV combinations.
- **ALWAYS** be alert and considerate while driving.
 - Be observant of other drivers, motorcyclists, bicyclists, and pedestrians.
 - Be vigilant to possible traffic and road conditions.
 - Prior to merging or changing lanes, check all mirrors for other vehicles, use a turn signal, and merge with caution.
 - Account for sudden braking and other possible unexpected events.
- **ALWAYS** operate daytime running lights on your tow vehicle to increase visibility to other drivers.
- **NEVER** drive when drowsy or tired, especially at nighttime.
- **NEVER** drive under the influence of drugs, alcohol, or medications that may impair your reflexes, alertness, or judgment.
- **ALWAYS** be aware that weather conditions and extreme terrain may affect your tow vehicle and RV performance and handling.
- **NEVER** use cruise control when roads may be wet, icy, winding, or any other traffic situations that may require rapid response and sudden reductions in speed.

- **ALWAYS** before operating a cellular device while towing your RV, be sure to know the local laws, and understand the dangers using your cellular device poses. Even if local laws permit using cellular devices while towing, you should only do so when parked, stopped at a traffic signal, or otherwise not in motion. Distracted driving can be as dangerous as driving under the influence.
- **NEVER** leave children or pets unsupervised in, or around the RV. Even children confined in child restraint systems (i.e., pack-n-plays, car seats, walkers, bouncers, swings, etc.) should be supervised to ensure safety.

Propane Safety

- **ALWAYS** shut off ALL propane appliances and turn off and secure LP tanks PRIOR to traveling. If driving with the LP system on or open, the level of danger will increase substantially in the event of a fire or accident.

WARNING

Utilizing a cellular device while driving, puts you and all other passengers at greater risk of accidents, injury, or even death. Distracted driving can be as or more dangerous than driving while intoxicated.

WARNING

Children and pets should be supervised at all times to ensure their safety remains your number one priority.

B. RV DRIVING SCHOOLS AND SEMINARS

If you have any concerns about towing your RV, consult an expert for tow driving education. There are many RV owner organizations and training facilities that offer tow driving classes and seminars. Brinkley RV is not affiliated with any of these locations or services. To obtain additional information and schedules you must contact the provider directly. Many can be found online, through RV publications, or at various RV campgrounds.

Be cautious when using websites and social media as a research tool. Always verify the information through various sites and always try to use accredited, reliable sources in the RV industry. Always make sure the information you are researching pertains to RV's. If you have any doubts or additional concerns, contact your Dealer or Brinkley RV Customer Care for assistance.

3. Axles and Suspension Options

Your unit may be equipped with one of the following options:

- a. Dexter 7000# Axles with Disc Brakes
- b. MorRyde 8000# Independent Suspension System.

Please refer to the manufacturers' documents at the links and QR Codes below for more information.

C. RV BRAKING SYSTEM

1. General

To maintain proper use and performance of your RV brakes, they must be used in combination with the brakes of your towing vehicle. RV brakes are designed to work alongside the brakes of your towing vehicle and should not be operated separately. If separately used, the brake system will experience accelerated wear, tear, and damage.

⚠ WARNING

Using only the trailer brakes can result in overheating that causes damage to the brake components and could potentially lead to a fire.

Brake controller (Customer Supplied).

- Wire harness and connectors.
- Towing 7-way plug.
- Auxiliary batteries (See Section 11E(3)).
- Breakaway switch.

2. Brake Controller

A brake controller (Customer Supplied) is highly recommended to assist in the performance of your brake system. It is installed in your tow vehicle and will assist in adjusting the sensitivity of the brakes. Please consult with your Dealer or the supplier of the brake controller to decide which controller is best for your RV and tow vehicle combination.



[Dexter 6K - 8K Axle
User Manual](#)

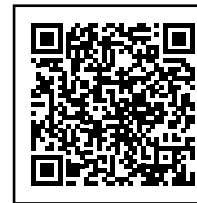

[MorRyde
Independent
Suspension System](#)

SEC.07 TOWING & HITCHING

D. 7-WAY HARNESS TOWING CONNECTOR PLUG

The 7-way wire harness, also known as the towing connector plug, is a wire harness that, when connected from the tow vehicle to the RV, will supply limited power to the RV. This limited power source is supplied to the RV brakes, clearance lights, running lights, turn signals, brake lights, etc. It also functions as a means of trickle charging the RV battery(ies).

**7-way RV Style Trailer Plug Wiring
(aka Pollock or Bargman plug)**

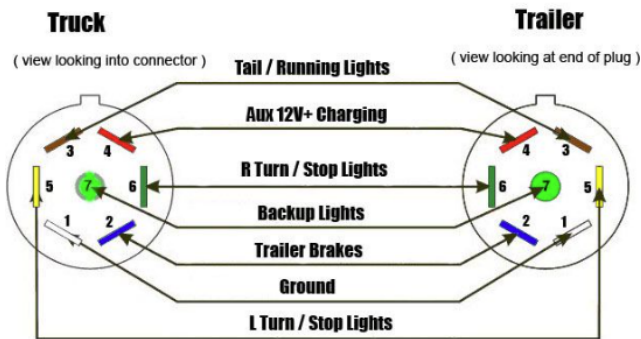

Maintenance

Due to weather and environmental elements, corrosion may form on the 7-way connector.

CLEAN the connector plug before every use to ensure proper electrical contact. **INSPECT** the connector plug frequently to ensure no damage or additional wear has compromised the housing on the plug that may further expose the wires to the elements as you travel. **REPLACE** if cracked, broken, or damaged.

⚠ WARNING

If the towing connector plug is damaged, you must replace it immediately. A failure to replace the towing connector plug when damaged may result in an electrical short leading to accidents, damage, fire, injury, and/or death. The connector plug provides all safety related lighting as well as power to your RV brakes.

E. BREAKAWAY SWITCH

On every RV, a breakaway switch is installed to ensure that if the RV becomes disconnected from the tow vehicle, the RV brakes will engage. Depending on your RV type, the breakaway switch is located on the pin box (fifth wheel) or A-frame (travel trailer) of the RV. The breakaway switch is a crucial part of the RV braking system and should NEVER be removed.

If the RV becomes disconnected from the tow vehicle, the cable from the breakaway pulls the pin from the switch and engages the RV brakes.



- **ALWAYS** secure the breakaway switch cable to a permanent location on the tow vehicle when hitching the RV.
- **ALWAYS** ensure the auxiliary battery (If Equipped or Customer Supplied) is correctly installed and is fully charged PRIOR to departing.

⚠ WARNING

The breakaway switch will only operate when it is supplied with power from an auxiliary battery (Customer Supplied or If Equipped). If you fail to install an auxiliary battery, there will not be power at the breakaway. This could lead to a catastrophic accident resulting in damage, injury, and/or death.

⚠ WARNING

NEVER utilize the RV's brakes or breakaway switch as a parking brake. When the RV brakes are engaged, they are energized and draw power from the converter and auxiliary battery (Customer Supplied). This form of misuse can lead to damage to the brakes, wiring, connectors, and breakaway switch and/or could lead to a fire.

⚠ WARNING

Always ensure that the breakaway switch cable is long enough to accommodate making tight turns. Failing to ensure the cable is long enough may result in the breakaway pin being pulled and engaging the RV Brakes. Such an occurrence may lead to significant damage or could cause a fire.

+ NOTICE

Your RV is provided with a Safety Break-Away Switch label. Do not remove or cover this label. If it is damaged, covered, or missing, it should be replaced immediately. The label should look similar to the following example:

**SAFETY BREAK-AWAY
 SWITCH WILL NOT OPERATE**
 unless connected to a power source
 equivalent to or greater than an automotive
 type 12 volt, 12 amp hour wet-cell battery

F. FIFTH WHEEL PIN BOX HITCH

1. General Information

Your RV is equipped with a Gen-Y pin box that utilizes the Lippert Rhino mounting bolt pattern. Please see the provided photo below.



There are many hitch assemblies available in the marketplace that vary in their specifications and use.

Hitch selection directly impacts towing and handling of your RV. Careful consideration is crucial when considering a pin box modification, upgrade, and/or replacement.

How each hitch type affects towing and handling should be considered if you are looking to purchase an aftermarket pin box. Make sure the proper hitch is selected for your specific RV and towing vehicle. Once that selection has been made, make sure your hitch is properly installed for a safe towing experience.

SEC.07 TOWING & HITCHING

A fifth wheel requires a pin box hitch (Customer Supplied) bolted directly to the floor of the truck box through the frame. Please contact your Dealer for the proper class and type of hitch you need to purchase for your individual tow vehicle and RV combination.

+ NOTICE

At the time of publication of this manual, the Brinkley RV Model Gx utilized a Gen-Y pin box with the Lippert Rhino mounting bolt pattern. From time to time, without notice, Brinkley RV may make changes to improve its products. As such, it is important for you to identify and verify the correct pin box type supplied with your RV and ensure that any aftermarket replacements are both compatible and authorized for use with your RV.

⚠ WARNING

The pin box that is provided at the time of purchase of your RV is specifically designed to work with your RV. It is critical that, if you decide to replace or upgrade your pin box, that you select a version that is compatible with and approved for use with your particular RV. Utilizing a pin box that is not designed for your particular RV application may result in catastrophic damage, injury and/or death. Further, utilization of an incompatible or unapproved pin box may void your warranty.

2. Gooseneck Pin Box

Lippert has multiple gooseneck pin boxes that are compatible with the frame utilized on your RV. If you wish to change to a gooseneck on your RV, it is highly recommended you contact your Dealer or Lippert directly for recommendation and assistance.

⚠ WARNING

Utilization of other gooseneck hitches may result in damage to the chassis, particularly the upper deck and sidewalls.

+ NOTICE

Utilization of unapproved pin boxes may void your chassis warranty from Lippert and your Brinkley RV supplied warranties if the pin box you utilize actually cause the damage to the chassis or RV.

3. Fifth Wheel Pin Box Height

Many fifth wheel pin boxes are adjustable to accommodate for the height variance in trucks and suspension systems. There is no recommended hitch height for fifth wheels but your hitch assembly should be adjusted so that your tow vehicle and RV are level.

- **When the hitch is adjusted too high**, the weight of the RV will shift to the rear of the RV, behind the axles and may cause the tow vehicle to fishtail as a result.
- **When the hitch is too low**, the weight will transfer forward and apply additional weight to the hitch. This, in turn, may affect handling and steering of the tow vehicle. To adjust the hitch to the proper height, please refer to the hitch manufacturer's instructions.

4. Standard Pin Box Hitching

TO SAFELY HITCH YOUR FIFTH WHEEL TO THE TOW VEHICLE, USE THE FOLLOWING STEPS:

1. **PARK** on a level surface. Ensuring your tow vehicle and RV are parked on a level and sturdy surface will ensure a solid kingpin connection and make it easier to back your tow vehicle up to the RV.
2. **ALWAYS** use wheel chocks on both rear RV tires to prevent the RV from moving.
3. **ENSURE** the fifth wheel jaws (hitch lever) are in the **OPEN**, or cocked, position (unless it opens automatically by design).
4. **OPEN** the tailgate (If Equipped) of the tow vehicle.
5. **BACK UP** the tow vehicle until the hitch is approximately 4" (10.16 cm) from the kingpin. Then, stop the tow vehicle and place it in park.
6. **ADJUST** the fifth wheel pin to the necessary height by adjusting the front RV jacks (landing gear legs) up or down as necessary. The plate on the front bottom of the pin box should be approximately ½" (1.27 cm) lower than the top of the 5th wheel hitch. You are now ready to hitch.
7. **BACK UP** the tow vehicle slowly until the kingpin is fully seated within the hitch. Gentle contact of the hitch saddle against the pin will cause the receiver to close. It is critical to inspect the connection to ensure proper engagement.
8. **SECURE** the hitch lever as specified by the manufacturer and install the provided safety pin into the handle.
9. **TEST** the connection. Place the tow vehicle into drive and slowly let off the brake pedal to allow the tow vehicle to lightly tug at the RV. If resistance is felt, the hitch connection is secure. If not, you will need to restart the process starting at step 1 above.
10. **CHECK** that the RV landing gear legs (front jacks) are fully **RETRACTED**.

11. **ATTACH** the breakaway switch cable to the tow vehicle. Leave enough slack to accommodate tight turns.
12. **CONNECT** the 7-way wire harness from the RV to your tow vehicle and secure in the travel position.
13. **WALK AROUND** the RV to verify the exterior lights are all working correctly.
14. **REMOVE** the wheel chocks from the trailer wheels.
15. **You** are now ready to tow the RV.

⚠ WARNING

NEVER climb under the RV while it is being towed, lifted, or leveled.

⚠ WARNING

Failing to follow the above-described hitching steps may lead to property damage, injury and/or death. Further, failing to retract the front jack(s) can lead to substantial damage to the jacks, your tow vehicle, and/or the RV.

⚠ WARNING

DO NOT USE THE LANDING GEAR LEGS (FRONT JACKS) OF THE FIFTH WHEEL TO SUPPORT THE WEIGHT OF THE TOW VEHICLE.

SEC.07 TOWING & HITCHING

5. Gooseneck Pin Box Hitching

TO SAFELY HITCH YOUR FIFTH WHEEL TO THE TOW VEHICLE, USE THE FOLLOWING STEPS:

1. **Follow** steps one through four found under the standard pin box hitching instructions.
2. **BACK UP** the tow vehicle until the hitch directly aligns with the coupler. Then, stop the tow vehicle and place it in park.
3. **ADJUST** the gooseneck coupler to the necessary height by adjusting the front RV jacks (landing gear legs) up or down as necessary. If you have an auto latching coupler, check to ensure the coupler engages. If you do not have an auto latching coupler, you will need to manually lock the coupler.
4. **SECURE** the hitch lever as specified by the manufacturer and install the provided safety pin into the handle.
5. **TEST** the connection. Extend the front landing gear slightly to ensure the hitch connection is secure. Do not over-extend the landing gear more than necessary to validate the connection, as damage to the hitch/frame/tow vehicle can occur.
6. **CHECK** that the RV landing gear legs (front jacks) are fully **RETRACTED**.
7. **ATTACH** the breakaway switch cable to the tow vehicle. Leave enough slack to accommodate tight turns.
8. **CONNECT** the 7-way wire harness from the RV to your tow vehicle and secure in the travel position.
9. **WALK AROUND** the RV to verify the exterior lights are all working correctly.
10. **REMOVE** the wheel chocks from the trailer wheels.
11. **You** are now ready to tow the RV.

G. TOWING THE RV

+ NOTICE

NEVER allow passengers to ride inside a towable RV while it is in motion. Towable RV's are not designed for occupants during transit and there are no safety or seat belts provided inside your RV. Further, it is against the law in many states for a towable RV to have occupants while in transit.

1. Braking and Stopping Distance

When towing an RV, be sure to allow for greater stopping distances. Before towing the RV, it is best to practice braking and stopping in a large parking lot (where allowed). This will allow you time to become familiar with the RV brake system and practice braking with your RV before driving in traffic. Your RV is a substantial amount of weight behind your tow vehicle, and it is imperative that you are comfortable with the additional distances required to safely stop.

- **AVOID** road conditions and situations that may require excessive and/or prolonged use of the RV brakes.
- Easing into a stop will increase the longevity of the brake life of your RV and tow vehicle. Failure to do so will result in additional wear and tear to the brake systems on both your RV and tow vehicle.

While descending a steep elevation, place the tow vehicle into a lower gear or lower gear range if your tow vehicle has an automatic transmission. This will allow the engine and transmission of the tow vehicle to help regulate the speed of the vehicle itself and in return extend the life of the brakes.

- Engage, then release the brakes in short intervals to allow for cooling.
- When driving in or through deep water, be prepared to increase stopping distances and be aware that wet brakes may cause the vehicle or trailer to pull to the side.
- If you notice the brakes diminish in effectiveness or are not operating as efficiently, **DO NOT** continue towing the RV until the brakes are inspected and replaced as needed.

- **ALWAYS** check the brake operation of the RV in a safe environment before traveling to ensure proper operation.

2. Weight and Clearance Limits

It is important to know the dimensions of the RV, as well as the Combined Gross Weight of the RV and Tow vehicle before traveling. This information is vital to ensure all posted Weight and Clearance Limits are properly followed.

- Remember that the RV height must include the roof air conditioners, TV antennas, solar panels, and floodlights as these may cause clearance issues under some tunnels, canopies, bridges, and/or hanging signs.
- Some bridges, particularly aged ones, may not support the weight of your RV combined with the weight of the tow vehicle. Some bridges may also be too low for your RV to pass under.

3. Road Conditions

Adjust driving accordingly to the road and environmental conditions.

- Slow down, then release the brakes prior to crossing railroad tracks or crossways.
- Sudden acceleration or deceleration in wet or icy conditions may cause sliding and ultimately loss of control.
- When there are potholes, dips, or bumps in the road, slow down well in advance to reduce jolting and bobbing of the tow vehicle and RV.
- When driving on uneven surfaces, reduce towing speeds. Before accelerating once more, ensure you are through the uneven section and well onto level surfaces.

4. Turning Corners

When turning, the RV will make a tighter turn than your tow vehicle and does not follow in the same path as your tow vehicle. To ensure you compensate for this difference, take wider turns with the RV. In intersections, you must carefully pull into the intersection further, so the RV has proper clearance for the turn.

⚠ WARNING

While turning, it is critical that you are completely aware of your surroundings and ensure proper clearances. Use caution when making turns to ensure that you avoid collisions with objects around you. When parking in tight locations, utilize a spotter as a guide. Use caution when taking sharp turns and corners and be aware that swerving while towing your RV can result in a loss of control, particularly at higher rates of speed.

5. Passing

When towing an RV, the tow vehicle is under greater load and will take longer to accelerate and reach highway speeds. Allow additional time when pulling out onto a road or while overtaking another vehicle. When changing lanes, always accommodate for the extra length of your RV. Be cautious of your surroundings and be prepared to change the speed of your tow vehicle and your lane quickly and safely

6. Backing-Up

When selecting a campsite, choose a level site that you can pull through or back into. Prior to parking your RV, inspect the campsite to ensure it satisfies your expectations and that there are no unforeseen obstructions.

- Ensure there is plenty of clearance for the RV.
- Make sure the path is free of ground level and/or hanging obstacles (i.e., large rocks, low dips, low-hanging limbs, electrical lines, etc.).
- It is best to choose a campsite that is on the driver's side.
 - Driver's side campsites allow the driver to better see the rear of the RV while parking
 - Passenger side campsites hinder parking skills due to it being on the driver's "blind side."
- Position the tow vehicle and RV for backing into the site location.
- Make sure there are no obstructed views before beginning to park your RV.

SEC.07 TOWING & HITCHING

- When reversing, do so slowly. Use the tow vehicle mirrors and cameras (If Equipped or Customer Supplied) to carefully guide you into the desired parking location.
- Use your passenger as an additional guide to assist you. This will eliminate any hidden blind spots.

7. Parking

Once the RV is in the desired position:

- Place the tow vehicle into park and engage any other possible parking brake..
- Turn the ignition of the tow vehicle **OFF** and remove keys.
- Block the wheels of the RV securely with wheel chocks (Customer Supplied).

H. UNHITCHING FROM THE TOW VEHICLE

After the RV is parked and the wheels are blocked from rolling, it is time to unhitch your RV.

UNHITCHING A STANDARD PIN BOX:

1. **STABILIZE** the RV by lowering the front landing gear legs (front jacks). For proper operation, refer to the manufacturer's instructions.
2. **DISCONNECT** the 7-way wire harness/connector plug connecting the RV and tow vehicle.
3. **UNCLIP** the breakaway cable from the tow vehicle.
4. **OPEN** the vehicle tailgate unless it is designed specifically for dovetail hitch connections.
5. Shift the tow vehicle into reverse, but **DO NOT** press the accelerator. This removes pressure off the locking bar, to allow it to properly disengage.
6. Once the pressure is alleviated from the locking bar, apply the brakes and place the tow vehicle back into park.
7. Disengage the locking bar and disconnect the pin box of the RV from the hitch of the tow vehicle.
8. After the pin box is fully released, slowly pull the tow vehicle forward. **DO NOT** pull away at an angle. Doing so may result in damage to the tow vehicle or RV.
9. Level the RV starting from front to back.

UNHITCHING A GOOSENECK:

1. **STABILIZE** the RV by lowering the front landing gear legs (front jacks). For proper operation, refer to the manufacturer's instructions.
2. **DISCONNECT** the 7-way wire harness/connector plug connecting the RV and tow vehicle.
3. **UNCLIP** the breakaway cable from the tow vehicle.
4. **OPEN** the vehicle tailgate unless it is designed specifically for dovetail hitch connections.
5. **Shift** the tow vehicle into reverse, but **DO NOT** press the accelerator. This removes pressure off the locking bar, to allow it to properly disengage.
6. **Release** the coupler lock and begin to lift the RV using the leveling system.
7. **Once** pressure is released, disengage the locking bar and disconnect the pin box of the RV from the hitch of the tow vehicle.
8. **After** the pin box is fully released, slowly pull the tow vehicle forward. **DO NOT** pull away at an angle. Doing so may result in damage to the tow vehicle or RV.
9. **Level** the RV starting from front to back.

WARNING

Fully retract the landing legs **PRIOR TO** moving the RV in any way to prevent damage.

NOTICE

When parking on gravel, dirt, or asphalt on a hot day, place a block of wood or pad under each landing leg to prevent them from sinking into the surface. Make sure the same material is used under each leg to ensure the load remains evenly distributed.

A. INTRODUCTION

The leveling system on the Model Gx is a hydraulic leveling system. This system includes six points of contact utilizing aluminum jacks and a multi-valve system. A 12V DC electric motor drives a hydraulic pump that moves fluid through a system of hoses, fittings, and jacks to level and stabilize the RV.

B. COMPONENTS

The leveling system is comprised of the following components:

Jacks—The unit is equipped with six (6) hydraulic jacks. The two (2) front jacks are commonly referred to as the “landing gear.” The rear four (4) jacks are commonly referred to as the “rear leveling jacks.” All jacks come equipped with 9” (22.86 cm) steel footpads on a ball swivel. The jacks are operated by a 12V DC Motor/Pump Assembly.

Motor/Pump Assembly—The motor/pump assembly is comprised of the following components:

1. A 12V DC Motor
2. A hydraulic fluid reservoir tank
3. A control valve manifold
4. A solenoid valve.

System Controls—The system can be controlled in fully automatic or manual mode by any of the following methods:

1. The Level-Up Touch Panel located on the driver side of the unit behind the pass-through storage baggage door.
2. The Firefly Control Panel (see section 16 of this Manual).

For more information and full details on the operation of your leveling system, click the link or scan the QR code below.



[Titan Leveling Product Support](#)

C. SAFETY

⚠ WARNING

Any attempts to change the tires, or perform other service, while 5th Wheel is supported solely by the leveling system could result in death or serious personal injury, severe product and/or property damage. Make sure the 5th Wheel is properly supported with jack stands, or other adequate devices, under the frame of the 5th Wheel prior to performing any service or repair procedure. Never support the 5th Wheel by the axles or suspension. Never allow the tires to leave the ground when lifting the 5th Wheel—this creates unstable and unsafe conditions.

⚠ WARNING

Make sure to keep hands and other body parts clear of fluid leaks. Fluid leaks in the leveling system may be under high pressure and can cause serious skin-penetrating injuries. Make sure all persons, pets and property are clear of the 5th Wheel while the leveling system is in operation. A fluid leak within a highly pressurized hydraulic system can cause serious skin-penetrating injuries. Wear appropriate Personal Protective Equipment (PPE), such as long sleeves, gloves, protective eye wear or a full face shield, when performing service or maintenance to the 5th Wheel.

⚠ CAUTION

Moving parts can pinch, crush or cut. Keep clear and use caution.

1. Make sure the 5th Wheel is parked on a reasonably level surface.
2. Clear all jack landing locations of debris and obstructions. Locations should also be free of depressions.
3. When parking the 5th Wheel on extremely soft surfaces, utilize load distribution pads under each jack.
4. Make sure the battery of the 5th Wheel is fully charged or that the 5th Wheel is plugged into shore power prior to attempting to operate the system.

+ NOTICE

The leveling system requires a minimum of 12V DC from the battery for proper operation. It is recommended that the leveling system be operated utilizing a fully charged battery.

+ NOTICE

The refrigerator and other appliances in the RV are designed to perform best when the RV is level. Additionally, the water system is designed to drain properly when the RV is level.

+ NOTICE

Slide-out rooms should remain in the retracted or in position until the RV is level. Leveling the unit first prior to running out the slide-outs will help to prevent water leaks.

D. PRIOR TO OPERATION

The leveling system shall only be operated under the following conditions:

1. The trailer is parked on a reasonably level surface.
2. The tow vehicle is disengaged from the RV.
3. Make sure all persons, pets, and property are clear of the trailer.
4. Make sure the battery of the trailer is fully charged or that the trailer is plugged into shore power prior to attempting to operate the system. The automatic leveling system requires a minimum of 12V DC from the battery for operation.



E. SYSTEM OPERATION

1. Auto Level Instructions

- a. After unhitching from tow vehicle press "AUTO LEVEL" button on the touch pad.
- b. Follow the instructions on the label on the compartment wall below the touch pad (image above)

+ NOTICE

Once the automatic leveling cycle has been started, it is important that there is no movement in the trailer until the trailer has completed the leveling process. Failure to remain still during the leveling cycle could have an effect on the performance of the leveling system.

A. GENERAL INFORMATION

Slide-out rooms are designed to provide you additional living space during stationary camping.

- To extend, retract, and to seal a slide-out correctly, the RV must be level. If the RV is NOT level, the slide-out rooms and/or their pertaining parts may become damaged or leak.
- Slide-outs do not need additional support. Any damage that results from such support may not be covered under the warranty. This includes any damage that may result from the improper use or use of aftermarket support jacks.

⚠ WARNING

Before operating any slide-out, review and understand all operation instructions and safety alerts.

⚠ WARNING

Slide-outs and slide-out mechanisms are crush hazards. Disable the auxiliary battery and flip the breaker on the distribution panel to cut power to the converter **BEFORE** working on or under a slide-out. Failure to do so may result in serious injury or death.

⚠ WARNING

Before extending or retracting a slide-out, make sure the surroundings are clear of objects, people, and pets. Failure to do so could result in serious injury or death.

+ NOTICE

Prior to operating a slide-out, ensure sufficient power is available and that the RV is properly leveled. Failure to do so may result in damage to your slide-out or slide-out mechanism.

B. OPERATION

It is normal for slide-outs to make noises such as squeaking or creaking while being operated. These noises are more common during the “break in period” of the RV and will continue until components and materials are seated properly. After a few uses, this noise will likely diminish.

SLIDE-OUT OPERATION:

1. **BEFORE** operating any slide, level and stabilize the RV.
2. **Ensure** wheels are properly chocked.
3. **Ensure** there is a energy source. If power is supplied by the campground, make sure you are properly connected. If you are running the slides with auxiliary power, make sure the battery is fully charged and all unnecessary lights and power consumption is limited to maximize available power for slide-out operation.
4. **PRIOR TO** extending or retracting the slide:
 - Close all cabinet doors and drawers.
 - Ensure the interior path for the slide-out is clear of people, pets, furniture, and/or any other possible object that may obstruct the slide-out’s path.
 - Ensure the exterior path for the slide is free of trees, electric lines, or any other possible obstructions.
5. To extend, press and hold the **OUT** or **EXTEND** button. Refrain from releasing operation until the slide motor stalls. If there is an obstruction, stop operation immediately. A slight delay may occur before the slide-out begins to move. This is normal.
6. **BEFORE** retracting, inspect the exterior walls, roof, and floor of the slide-out. If any of the surfaces are wet, be sure to dry them before retracting.
7. **If** water puddles or debris are present from the use of a slide, clean and dry the area immediately.

8. To retract, press and hold the **IN** or **RETRACT** button. Retrain from releasing operation until the motor stalls and the room is completely retracted. If there is an obstruction during operation, stop immediately.

+ NOTICE

There will always be some noise that accompanies the operation of extending and retracting the slide-out.

⚠ WARNING

The slide-out mechanism contains sharp edges. To prevent injury, **DO NOT** allow children to play under the slide-out under any circumstance. **BEFORE** working on or going under a slide-out, make sure **ALL** power to the slide is disconnected. Failure to do so may result in serious injury or death.

⚠ WARNING

Ensure all slide-outs are fully retracted **PRIOR** TO hitching the RV to the tow vehicle. Failure to do so may result in damage to your RV, serious injury, or death.

+ NOTICE

For the slide-out to seal correctly, the room must be fully extended or retracted. Once the slide-out is fully extended or retracted, release the slide switch immediately. Running the switch beyond slide extension may result in damage to the slide-out motor.

⚠ WARNING

Do not place excessive weight within the slide-out. Overloading a slide-out may result in malfunction leading to damage to the slide mechanism, injury, or death.

+ NOTICE

For long-term storage, it is recommended that all slide-outs be stored with slide rooms fully retracted.

C. SLIDE-OUT MAINTENANCE

While a slide-out is fully extended, the slide surfaces will be exposed to and will collect water, dirt, ice, and other miscellaneous debris. Slide-out seals are not designed to remove such debris. All slide-out exterior surfaces should be dry and clean prior to retracting the slide.

D. SLIDE-OUT SYSTEMS USED

One slide mechanism utilized by Brinkley RV is the Lippert Through Frame Hydraulic Slide-out System. This system's function is to allow the slide room to extend and retract at the push of a button. The through-frame hydraulic system is a **rack-and-pinion** guided system utilizing a hydraulic cylinder to move the room assembly and is operated as a negative ground system.

The power unit pressurizes the hydraulic transmission fluid and the fluid pressure then causes the cylinder rod to extend and retract. Please refer to the manufacturer's manual for complete instructions on use, maintenance, limitations, and warnings by clicking the link or scanning the QR Code below.



[Lippert Through Frame Hydraulic Slide-out Owner's Manual](#)

Another slide system utilized by Brinkley RV is the Lippert SlimRack® system. Unlike a through frame that passes through the RV chassis, this system is mounted to the wall structure of the slide-out box.



[Lippert SlimRack Slide-out Owner's Manual](#)

+ NOTICE

It is normal for slides to make noises such as squeaking or creaking while being operated. These noises are more common during the "break in period" of the RV and will continue until components and materials are seated properly. This will lessen over time.

A. GENERAL INFORMATION

Your RV is equipped with a HappiJac Power Bed Lift system. The HappiJac Power Bed Lift effectively maximizes existing vertical space, providing room for additional storage or sleeping/sitting area. This system is comprised of an upper, queen sized bunk and two lower, reversible sofas on a vertical lift system.

This entire system can be operated by the touch of a button at the remote panel. This remote panel is located on a wall in the garage area. A photo of the panel is shown below.



B SAFETY PRECAUTIONS

Prior to operating the HappiJac lift system, there are a few safety precautions that should be taken into consideration.

- **ALWAYS** raise the bed(s) to the full up position when the trailer is being towed to avoid damage to the bed lift system as a result of road vibration.
- **ALWAYS** make sure that the areas above, below and adjacent to the bed(s) are free from obstructions before operating the bed lift.
- **ALWAYS** check before operating lift to ensure that there is nothing interfering with the travel of the chain mechanism inside the c-channel.
- **ALWAYS** use care when loading cargo/vehicles in the garage area. This is to avoid damage to the bed mechanism.
- **ALWAYS** properly secure loads in the garage area to avoid damage to the bed mechanism from shifting or falling loads.

- **NEVER** operate the bed lift with any items other than bedding on the bed platform(s).
- **NEVER** travel with any items other than bedding on the bed(s), unless secured. Loose items can become projectiles.
- **NEVER** operate the bed lift when persons or pets are on the bed platform.
- **NEVER** hang from, or hang more than 20 pounds, on the cross-connecting shaft.

⚠ CAUTION

Moving parts can pinch, crush or cut. Keep clear and use caution.

C. OPERATION

Prior to operating the HappiJac Power Bed Lift System, please be aware of all the warnings, instructions, and information found in the [manufacturer's manual](#).

1. General Operation

The general operation of the HappiJac Power Bed System is relatively simple and can be performed by only one person. Please see the instructions below.

OPERATING THE BED LIFT:

1. Locate the remote panel in the garage area. Press and hold the bed lift UP button shown in the below photo to raise the bed lift.



2. Continue to hold the UP button until the limit switches (micro switches) stop the lift's movement. Your bunks will now be in the up/stowed position.



3. Press and hold the DOWN button until the limit switches stop the lift's movement. Your bunks will now be in the down position.

2. Stowing/Locking the Upper Bunk

The bed lift system has a stow feature for the top bunk which leaves it in the travel position at the ceiling while allowing the lower bunk/sofas to travel independently.

+ NOTICE

Prior to traveling with your RV, the upper bunk should always be placed in travel mode.

1. Rotate both the lower sofas into their bunk positions.



2. Locate the locking mechanism found at each vertical post of the lift assembly. Flip the locking mechanism tab shown in the top right photo so the long portion of the tab is outside of the C-channel.

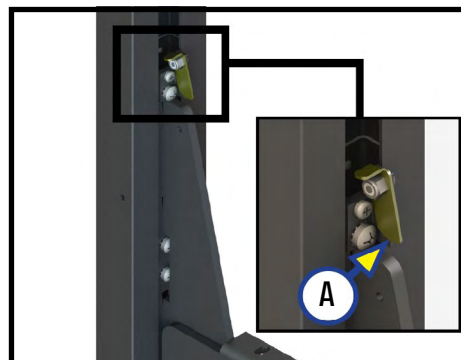

3. Repeat step 2 at each locking mechanisms.
4. Locate the operation switch at the monitor panel, and run the lift system until both bunks are in the closed or up/stowed position.



+ NOTICE

There is an audible click when the locking mechanism engages. If the mechanism fails to latch, check to make sure the bunk lock assembly bolt is not too tight and that the bunk lock assembly mechanism springs back freely within the C-channel.

5. Lower the bottom bunk to the desired height.
6. Return the lower bunk to sofa position if desired.

+ NOTICE

Utilize steps 1 through 4 to place the Happijac system into travel mode. Omit steps 5 and 6.

3. Un-Stowing/Releasing the Upper Bunk

1. Rotate both the lower sofas into their bunk position if they are not already in this position.



2. Flip the locking mechanism tab shown in the below photo to the release position, where the long portion of the tab is inside the C-channel. Repeat for the other locking mechanisms at each vertical post of the bed lift.

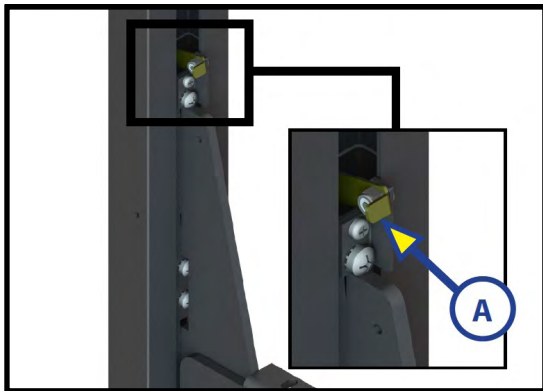

3. Run the lift system until both bunks are in the closed or up/stowed position.



4. Press the UP button on the remote panel to further lift the upper bunk. This will release the bunk from the locking mechanism.



5. Press the DOWN button on the remote panel to lower the upper and lower bunk/sofas.



For full instructions on the HappiJac Bed Lift System instructions, please click the link or scan the QR Code below.



[HappiJac Power Bed Lift Owner's Manual](#)

SEC.11 ELECTRICAL SYSTEMS

A. GENERAL INFORMATION

Your Brinkley RV Fifth Wheel is equipped with a 120-volt 60hz AC power and a 12-volt DC power system. The electrical system and all its components are engineered and designed specifically for RV's. All installations and components utilized meet or exceed the RV industry standards applicable as of the date the RV is manufactured.

- Hazardous conditions may occur as a result of aftermarket modifications or additions made to the RV pertaining to the RV electrical system.
- Modifying or making unauthorized additions within the RV is NOT recommended by Brinkley RV.
- ONLY your Authorized Dealer or a qualified electrical technician should perform service to the electrical system within the RV.

When providing maintenance or repairs to the RV, only components, methods, and materials that follow current safety and code requirements are permitted. Please consult with your Authorized Dealer's Service Center for assistance

⚠ WARNING

Use caution when working on the electrical system, especially when using metal tools. When a metal tool encounters a live, powered source it will cause the system to short circuit potentially resulting in personal injury, property damage, explosion, or fire.

B. ELECTRICAL SYSTEM MAINTENANCE

- **BEFORE** working on or near an electrical system, **ALWAYS** disconnect the negative 12-volt terminal on the battery and the shore power cord.
- **PRIOR TO** disconnecting the battery, **ALWAYS** make sure the power to the converter is turned off. Failure to do so, may result in damage to your RV or personal injury.

For more information on the electrical system within the RV, please refer to the component manuals in the Owner Information Package.

⚠ WARNING

The power cord **MUST** be fully extended and not coiled on the ground or in the compartment when in use. When the power cord is left in a coil, it may generate enough heat to melt the protective casing resulting in damage to the RV, personal injury, or fire.

C. 50 AMP POWER CORD

The power cord commonly referred to as the shore cord or shore power cord connects the RV to an external power receptacle commonly found at campsites. On the Model Gx, the shore power inlet is inside the off-door side pass-through bay, under and to the right of the Nautilus Convenience Panel (See pictures below).



1. Shore Cord Power

The purpose of this power is to:

- Supply an electrical feed from the external power receptacle to the RV.
- Supply proper ground to the electrical system within the RV from the external power source

CONNECTING POWER:

1. Disconnect power to the load center by flipping the main 120-volt circuit breaker.
2. Extend the shore cord from the RV and fully stretch the cord so it is not coiled.
3. Connect the shore cord to the RV.
4. Plug the shore cord into the external power source provided. Ensure that all prongs on the shore cord are fully seated within the external receptacle.
5. Returning to the RV, flip the load center breaker back to the ON position.
6. Follow the below instructions to help prevent damage from occurring due to power surges:
 - Disconnect the shore power cord any time the RV is left unattended. This will lessen the damage if a power surge were to occur while you are away from the RV.
 - Prevent damage from occurring to the prongs of the shore cord when connecting and disconnecting from external power sources.
 - When departing or needing to disconnect the power source, follow steps:
 1. Unplug the shore cord from the external power source.
 2. Disconnect the shore cord from the RV.
 3. Recoil the shore cord via the cord reel.

+ NOTICE

PRIOR TO connecting the RV to ANY external power source, ALWAYS test the external power with a Line Monitor or Clarity Tester (Customer Supplied). If the receptacle or source indicates Reverse Polarity or an open ground, DO NOT connect the RV.

2. Power Cord Maintenance

Frequently inspect the components of the power cord for cracks, cuts, worn/melted insulation, and exposed wires. If any of these conditions are present, discontinue use and replace immediately before continuing use.

⚠ WARNING

Circuit breakers and fuses are meant to function as a safety measure that will disconnect power once the system becomes overloaded or compromised but will not offer complete protection from events such as voltage spikes or varying surges.

⚠ WARNING

Any breaker that is replaced must be replaced with that of the same amperage ratings and type as the one removed. NEVER use a higher rated replacement circuit breaker. Failure to follow this instruction may result in overloading the wiring system ultimately leading to overheating, damage to the RV, and/or fire.

⚠ WARNING

For 50 amp systems only: Ensure that the external power source is a 50 amp NEMA 14-50 RV receptacle and NOT a 240-volt AC receptacle.

SEC.11 ELECTRICAL SYSTEMS

D. 120 VOLT AC SYSTEM

1. General Information

Your Brinkley RV fifth wheel is equipped with a 50 amp electrical service. This service is designed to operate on two (2) 120-volt power legs at a maximum flow of 50 amps/leg. When connecting to an external power source, the source must be a 50 amp service. When connecting to electrical service at a campground, the electrical service may occasionally experience spikes or drops in voltage.

+ NOTICE

Voltage spikes and drops can damage and/or shorten the service life of the electrical system and all the components it supplies power to.

The below electrical components will **ONLY** operate when the RV is connected to shore power or when operating the generator:

- Air conditioner
- Converter
- Various Receptacles
- Fireplace
- Water Heater

For recommendations on power-surge protection and protectors, please contact your Dealer

2. 120-Volt Circuit Breakers

All 120-volt AC circuit breakers are located within the load center that can be found in various locations depending on the floor plan of your unit. These breakers function to protect 120-volt wiring and their supplied components. Each breaker found within the load center will be identified and labeled.

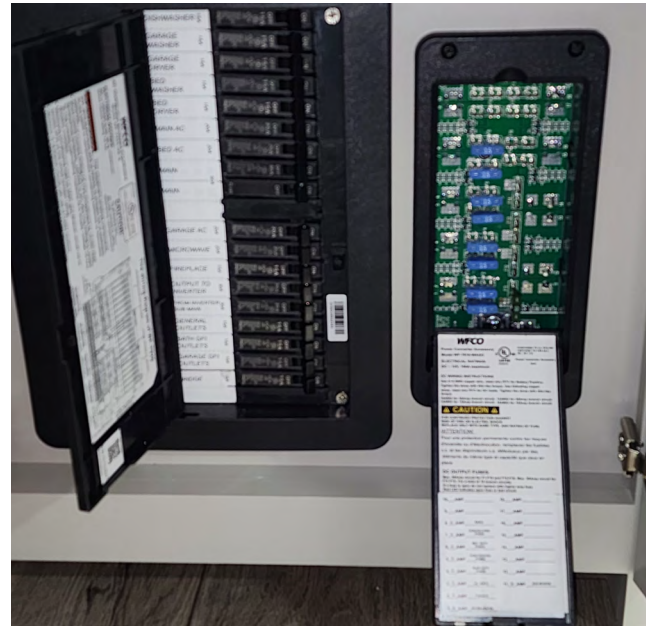

- If an overload or short circuit occurs, the corresponding breaker will trip causing the electrical flow to stop beyond the breaker itself.
- Once the breaker trips, allow time for the breaker to cool.
- To RESET the tripped circuit breaker, flip the breaker switch to the OFF position and then flip it back to the ON position.
- Contact your Authorized Dealer to diagnose and repair the electrical system if a given breaker immediately trips once it is reset or if it frequently trips in a short amount of time.

3. Maintenance and Replacement

Circuit breakers can wear out over time due to extensive use or exposure. Breakers should be inspected on an annual basis prior to the start of camping season. Replace breakers as needed but be sure they are replaced with the same rating and type that were originally installed.

⚠ WARNING

To confirm the circuit breakers are operational, flip the breaker to the OFF position and then back to the ON position. As soon as you recognize unusual operation, discontinue use, and contact your Dealer for further testing and assistance. Failure to do so may result in damage to the RV, personal injury, or fire.

4. Converter

The converter within the RV converts 120-volt AC power to usable 12-volt DC power once the RV is connected to an external power source via the shore power cord. This converter is located behind the load center and contains two 35 amp fuses to protect the converter from overheating. If overheating occurs, it is generally due to operating too many 12-volt systems at the same time for an extended period with little to no airflow.



[WFCO Electronics](#)
[Converter Product](#)
[Support](#)

To help prevent overheating from occurring:

- Do not utilize unnecessary 12-volt systems (i.e., lights, motors, appliances, etc.).
- Keep the cooling fan clear of any obstructions.
- Allow for proper ventilation in high temperature weather conditions.

5. Inspection and Maintenance

If the converter is not functioning or if the auxiliary battery is not charging when connected to shore power, it should be inspected.

CONVERTER INSPECTION WHEN BATTERY DOES NOT CHARGE:

Locate the converter (located in a front compartment behind an access panel). Locate the two (2) 35 amp fuses on the converter. Inspect and replace the fuses as needed.

For further assistance, please contact your Dealer.

+ NOTICE

Do not remove the converter from the RV or tamper with the housing. Doing so will void warranty. There are no serviceable parts within the converter that should ever be tampered with.

6. GFCI Receptacle

Ground wires help to stabilize current and offer a secondary path for electrical currents to travel in the case of exposure to a high voltage spike. This in return helps to prevent an electrical shock.



SEC. 11 ELECTRICAL SYSTEMS

Every Brinkley RV contains ground fault current interrupters (GFCI) designed specifically for the electrical system within your RV. GFCI's are designed to monitor the flow of electrical current between hot and neutral conductors and sense if an abnormality occurs. This circuit and device are designed with the intent to reduce possible injury caused by an electrical shock.

+ NOTICE

A GFCI will not protect against circuit overloads or short circuits.

When a GFCI receptacle senses an abnormally high 120-volt current present through the grounding circuit, the GFCI will trip. This occurrence will generally happen when wires become wet inside an appliance, faulty wire insulation, a short within electrical equipment, etc.

FREQUENTLY TEST GFCI RECEPTACLES

TESTING A GFCI:

1. Push the TEST button on the receptacle. This should immediately pop the reset button which indicates the GFCI has been "tripped". Once tripped, no 120-volt power will flow through the receptacle.
2. Verify no power is present. This should be done with a receptacle tester (Customer Supplied).
3. Once you are sure no power is present, press the **RESET** button. This should restore the flow of 120-volt power.
4. Verify the presence of power with the same receptacle tester.
5. If the GFCI does not test properly or is defective, please contact your Dealer for assistance.

E. 12 VOLT DC SYSTEM

Many RV components including the water pump, lights, motors, slide-out's, leveling, and appliances operate on 12-volt electricity.

- The converter will convert 120-volt to 12-volt power when the RV is connected to external power. The converter also charges the auxiliary battery when the RV is connected to a power source.
- The auxiliary battery supplies 12-volt power to the RV when no external power is supplied but should not be used as the main electrical source.
- When towing, the alternator of the tow vehicle will supply 12-volt power if the 7-way wire harness is properly connected and the tow vehicle engine is operating.

The 12-volt power, from the 7-way, runs many of the key components needed for travel including brake lights, turn signals, running lights, and the breakaway switch. In addition to supplying power to these essential components, the 7-way wire harness will also provide a power source to charge the auxiliary battery within the RV.

1. 12-Volt DC USB Ports

Within your RV you will find several 12-volt DC USB ports (i.e., in living room end tables, the sofa center console, some receptacles, etc.). When using these outlets, only use them on appliances and components that only require 12-volt and consumes less than 60 watts, or 5 amps. To prevent short circuits from occurring, keep all 12-volt USB ports free of any debris or foreign material.

2. 12-Volt Fuse Panel

- Within the 12-volt fuse panels, labels will indicate the fuse locations, sizes, and component it powers. Never remove any of these labels.
- Inspect all fuses on a periodic basis, especially prior to camping season and replace as needed.

+ NOTICE

In the event of a power spike or surge, fuses may not offer complete protection for you or the RV.

REPLACING FUSES:

ALWAYS turn off or unplug components **PRIOR TO** replacing a fuse. This will help to protect the components within the RV.

1. Before beginning, disconnect the shore power cord from the external power source.
2. Disconnect the negative terminal from the auxiliary battery within the RV.
3. Access the fuse panel and inspect fuses.
4. Remove the fuse by pulling straight back on the fuse from the fuse block.
5. Replace as needed.

Please contact your Dealer if the fuse is not blown and you are still experiencing electrical issues or if a circuit keeps blowing a fuse.

⚠ WARNING

Never replace a fuse with one that contains a different amperage rating or another type other than the original. Failure to do so may result in personal injury, damage to the RV, or fire.

3. Auxiliary Battery(ies)

Within the RV there are multiple 12-volt circuits. When all circuits are combined, the voltage load tends to be much greater than what the converter is capable of handling and auxiliary battery power is needed.

For efficient sustainability, a 200Ah battery bank (2-100Ah batteries or 1-200Ah battery) has been installed in your RV. This is located in the front bulkhead storage compartment of the RV. To monitor the voltage of the battery bank, a battery monitor has been installed within the RV. See [Section 11I\(4\)](#).

4. Dry Camping

Dry camping, also known as boondocking, involves camping in your RV with no electrical or water hookups. Prior to dry camping with your RV, make sure the battery bank is fully charged. If the components within the RV are strictly running off the power supplied by the battery bank, and the battery bank is not being charged by the generator (If Equipped) or solar, the battery bank will deplete in charge over time and will deplete at a faster rate the more power that you require. As an auxiliary battery becomes depleted and the charge lessens, it will discharge at a faster pace. It is highly recommended that you plan your electrical usage accordingly.

To ensure your battery is fully charged, test the auxiliary battery voltage using a volt-ohm meter. A fully charged 12-volt LiFePO4 battery will have a charging voltage of around 14.6-volts and a resting voltage of around 13.6-volts. Many LiFePO4 batteries can discharge 100% of their rated capacity every time with no ill effects. However, many manufacturers recommend discharging only 80% to maximize battery life. The low-voltage cutoff of many 12-volt LiFePO4 batteries is around 10-volts. The battery monitoring system should detect when the battery voltage falls below 10-volts and enter a sleep mode to protect the battery cells from over discharge. Low-voltage cutoff is also called low-voltage disconnect, which you'll sometimes see abbreviated "LVD."

SEC.11 ELECTRICAL SYSTEMS

+ NOTICE

Some batteries have higher cutoffs, such as 10.6-volts. Please be aware that the limit listed in the battery manual may not be exactly 10-volts.

Under normal conditions, the battery bank provides 200 amp-hours (Ah) of power. To determine the duration (in hours) of your battery power, take the battery amp-hour rating divided by the number of amps you are using. In Section 11G, you will find the Amperage Chart for your RV that lists the normal amperages of the various components.

For example, if you are running the dinette lights (1 amps), the microwave (12 amps), and the water heater (12 amps) simultaneously, your battery power would last 8 hours.

$$200 \text{ Ah} / (1+12+12 \text{ amps}) = 8 \text{ hours}$$

**TOTAL BATTERY DURATION IN HOURS =
(Battery Amp-Hour Rating)/(Components Ran)**

In some cases, it is possible for the RV to drain the battery of the tow vehicle when the tow vehicle is not running, but is still connected through the 7-way plug to the RV.

To prevent this from occurring, disconnect the 7-way plug when the tow vehicle is parked, and the engine is not running. Another way to prevent this from occurring is to install a Battery Isolator (Customer Supplied) on the tow vehicle. The Battery Isolator will act as a charging mechanism that will allow the tow vehicle to charge the battery within the tow vehicle itself as well as the RV battery while the tow vehicle engine is running.

+ NOTICE

It is very important NOT to discharge your tow vehicle battery below the level required to start the engine.

5. Maintaining/Replacing 12V Equipment

Several components within the RV continuously draw battery power, even when the components are turned off (i.e., radio, TV, microwave, power tongue jacks, safety related equipment, etc.). The on-board memory of these components requires continuous power to save the memory. To prevent the auxiliary battery from being drained while not connected to shore power, utilize the master battery disconnect to fully disengage the battery. While the unit is in storage, it is best to remove the battery and place it on a battery maintainer. If you are unable to do so, it is suggested to check the voltage on the battery monthly and recharge as needed.

When purchasing a new battery or replacing an old battery, the amp hours, voltage, and type must be the same.

⚠ WARNING

Brinkley RV recommends that when replacing a battery, match the original's voltage, amp hours (Ah), and type (e.g., AGM, Lithium, Lead-Acid) to avoid potential electrical system damage, fire, or severe injury. The battery should be a 12 volt, 100 Ah minimum battery. If you must change the battery type, consult a qualified technician for assistance with setting up your unit to properly and safely function with the new battery.

For additional information or maintenance instructions, please contact the battery manufacturer for further assistance.

+ NOTICE

NEVER reverse the positive and negative terminals on the battery cables. Doing so will cause reverse polarity and blow the fuse protecting the converter.

F. BATTERY DISCONNECT SWITCHES

You will find two (2) battery disconnects within the RV: the travel battery disconnect and the master battery disconnect.

The **travel battery disconnect** will prevent components from drawing power from the battery but will still allow any memory-based appliances to maintain memory, operation of the refrigerator, safety components (such as the CO alarm, brakes, running lights), solar charging and the front jacks to maintain enough battery draw to function. The travel battery disconnect is located in the pass-through storage compartment on the door side of the RV.

The **master, or main, battery disconnect** will disconnect all power to every component within the RV including those that are memory-based, or safety related. It kills power to everything. The master battery disconnect is in the front bulkhead (or firewall) storage area. Please see the below photo.



When auxiliary power is not needed for short term, the travel battery disconnect should be utilized.

- **TURN** the Battery Disconnect Switch from the **ON** position to the **OFF** position.
- The items listed above will remain operational.

When the RV will not be in use over an extended period of time or is placed in storage, the master, or main, battery disconnect should be utilized.

- **TURN** the Battery Disconnect Switch from the **ON** position to the **OFF** position.
- **ALL** power will be disconnected, and **NO** power will be supplied to any component including any 12-volt safety or memory-based items.

G. CALCULATING ELECTRICAL LOAD

1. General Information

When connected to external shore power, the 120-volt AC system is capable of running a maximum of 100 amps momentarily and 50 amps on a continuous basis. If this rating is exceeded, the RV and/or electrical system of the campground may become overloaded, and as a result the main breaker will trip.

+ NOTICE

DO NOT exceed the combined amount of 100 amps at any given time. To calculate the amps used, the draw of all components being utilized must be added together. To calculate an amperage rating for an appliance, take the wattage of the appliance divided by the voltage. Both the wattage and voltage should be listed on the appliance. For example: A 120-volt appliance rated at 1200 watts would utilize $1200 \text{ watts} / 120\text{-volts} = 10 \text{ amps}$.

SEC.11 ELECTRICAL SYSTEMS

120 VOLT SYSTEM		12 VOLT SYSTEM		12 VOLT SYSTEM	
AIR CONDITIONER	14-18 AMPS	AISLE LIGHTS	0.5 AMPS	LP DETECTOR	0,125 AMPS
COFFEE MAKER	6-12 AMPS	BAGGAGE COMPARTMENT LIGHTS	0.5 AMPS	PORCH LIGHT	1.5 AMPS
CONVERTER (EACH)	8-11 AMPS	DECORATIVE WALL LIGHTS	0.5 AMPS	POWER AWNING	10 AMPS
CURLING IRON OR HAIR DRYER	10-14 AMPS	DINETTE LIGHT	0.5-1 AMPS	POWER VENT	5 AMPS
MICROWAVE	12 AMPS	FANTASTIC (VENTILATION) FAN	1.5 AMPS	REFRIGERATOR	5.3 AMPS
SATELLITE RECEIVER	2 AMPS	3" LED PUCK LIGHTS (EACH)	0.22 AMPS	SHOWER LIGHT	0.22 AMPS
TV	2-4 AMPS	FURNACE	8-10 AMPS	TV PLATE/ ANTENNA BOOSTER	1 AMP
VACUUM CLEANER	8 AMPS	GENERATOR START	95 AMPS*	VANITY LIGHT	0.22 AMPS
WASHER/DRYER	12 AMPS	ILLUMINATED SWITCH	0.125 AMPS	WATER HEATER	6 AMPS
WATER HEATER	12 AMPS	LEVELING SYSTEM	95 AMPS*	WATER PUMP	7 AMPS

*Momentary Load

2. Approximate Electrical Load Ratings

Please see the above amperage chart to obtain the amps used by each component.

H. REPLACING LIGHT BULBS

Prior to replacing a light bulb, always make sure the light switch is turned off. This will prevent the flow of power to the light itself. Always make sure the light bulb is the appropriate size and type. If an incorrect bulb size is used, the electrical circuit can become overloaded causing the fixture to overheat and could cause a fire. Light bulb replacement is deemed Customer maintenance and are provided by the Customer. *Light bulbs are not covered by any warranty.*

I. SOLAR POWER

A solar power system effectively charges the battery by converting solar energy to usable 12-volt power. As the battery becomes fully charged, the charge control system will protect the battery from overcharging by limiting the feed of solar power supplied. In your RV, the solar system provides power to all 12V system and to the inverter.



The inverter in return will permit operation of the GFCI 120V outlets, refrigerator, and air compressor. Your Brinkley Model Gx RV is equipped with a total of two (2) solar panels. Each solar panel is 200-watts and are installed on the roof of your Brinkley RV. These panels are wired in series and provide up to a total of 400-watts. Shown above is a photo of a standard 200W solar panel equipped on the roof of your Brinkley RV (location may vary by floor plan).

1. Solar Docking Port

The solar docking port inlet mounts directly on the roof of the RV and accepts the plug from the solar panel battery charger which enables you to charge your RV's 12V battery safely and quickly. The picture below left is a close-up view of the Solar Docking Port. The below right photo highlights the location of the Solar Docking Port relative to the solar panel. The photo to the right shows the Solar Docking Ports.

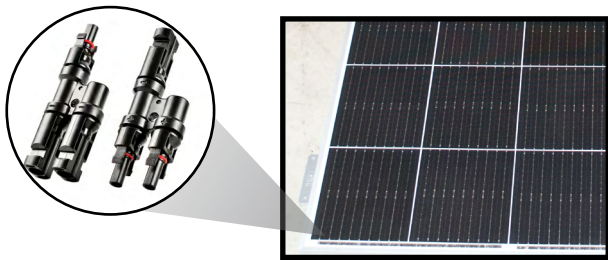

2. Solar Power Charging System

Your unit is equipped with a Victron MPPT Solar Charge Controller and a Victron MultiPlus-II Charger/Inverter.

For more information about this system and these components, please click the links or scan the QR codes at right for the Victron documents.

+ NOTICE

All safety alerts, warnings, and instructions should be followed when installing and/or using any Solar Power.



[Victron Smart Solar MPPT Charge Controller](#)



[Victron MultiPlus II Charger/Inverter](#)



SEC.12 GENERATOR

A. INTRODUCTION

The generator within your RV converts mechanical power, or fuel-based power, into usable 120-volt electrical power. This usable power will allow you to operate all 120-volt and 12-volt appliances and recepts while disconnected from shore power or while dry camping.

1. Safety Precautions

Prior to utilizing the generator within your RV, it is vital to understand the operational instructions and all safety related precautions. Please refer to the [manufacturer's manual](#) for this information.

- **NEVER** operate the generator in a confined space or within an enclosed building.
- **DO NOT** operate the generator if the exhaust is blocked, cracked, or incapable of dissipating the emissions.
- **DO NOT** operate the generator near tall or dry brush, grass, or other vegetation.
- **DO NOT** operate the generator when in close proximity to other objects, buildings, vehicles, snow walls, etc. that may block the generator's exhaust or become damaged by the heat.
- **DO NOT** operate in close proximity to open windows, tents, powered vents, etc. that may be exposed to the exhaust of the generator.
- **ALWAYS** allow the generator to cool prior to performing maintenance.
- **DO NOT** have an open flame or smoke near the generator while operating.

⚠ WARNING

NEVER OPERATE THE GENERATOR WHEN SLEEPING. Generators emit high levels of carbon monoxide when operating. While sleeping, you will unlikely notice emissions entering the RV if external factors abruptly change causing improper dissipation of exhaust fumes. Failure to recognize the presence of generator exhaust may lead to carbon monoxide poisoning or worse, death.

⚠ WARNING

NEVER place or store flammable liquids or materials near or in the generator compartment. During operation, the generator will emit heat which may ignite anything flammable.

⚠ WARNING

DO NOT touch the generator while in operation or immediately after disengaging. Heat from the generator may cause burns. Prior to performing maintenance, ensure the generator has cooled to ambient temperature.

+ NOTICE

The generator installed on your RV is not equipped with an in-line conditioner or internal surge protector and is not intended to power sensitive electronics that may be utilized within your RV. Such electronics may include, but are not limited to, cellular devices, computers, printers, specific TVs, audio/video equipment, etc. Prior to powering any sensitive electronic, please contact your Dealer about an in-line conditioner or filter (Customer Supplied)

2. Before Operating the Generator

Engine break-in on your generator is vital for peak performance. Proper generator break-in increases the performance of the engine while prolonging the life of the generator itself. For break-in instructions, see the manufacturer's manual below.

Before operating the generator:

- Verify the correct fuel source is selected and that fuel is available.
- Inspect for possible leaks on the fuel lines, LP lines, and exhaust.



[RVMP Flex Power Generator Product Support](#)

- Inspect all generator components for damage or loose connections.
- Ensure all carbon monoxide detectors are properly functioning.
- Turn off any major component or power draw within the RV.
- Check the oil of the generator to ensure it is at the proper level.

3. Generator Control Panel Basics

The control panel for the 5500i model is located behind the maintenance access cover and is equipped with many features. These features are outlined within this section.

- Push button start:
Push and hold for 1 second to automatically start the engine and push again to stop.
- Status indicator lights
 - **Low oil LED**
This light indicates low oil level and will not allow the engine to start or run.
 - **Overload / Output ready LED**
The 5500i model uses a single LED for these two functions. When this light is green, this indicates that the generator is ready to use. When this light is red, this indicates a general system electrical overload.
- ON/OFF 20 Amp Output Circuit Breaker
The 5500i model uses two separate circuits as the AC output, a 20 amp circuit and a separate 30 amp circuit. The 20 amp circuit breaker automatically trips when the 20 amp circuit is overloaded to protect the generator and the appliance(s).
- ON/OFF 30 Amp Output Circuit Breaker
The 30 amp circuit breaker automatically trips when the 30 amp circuit is overloaded to protect the generator and the appliance(s).
- Reset button
If the generator is overloaded, the inverter will disconnect at the AC overload breaker. The engine will continue to run but there will be no electrical output. Reduce the electrical loads, then push the reset button, and then turn the breaker back to “ON.”
- Gasoline Primer button
Press and hold the primer button to actuate the gasoline pump to bring fuel from the fuel tank to the generator engine. This is typically only needed the first time the generator is operated or after returning the generator to operation after being disconnected from the RV.

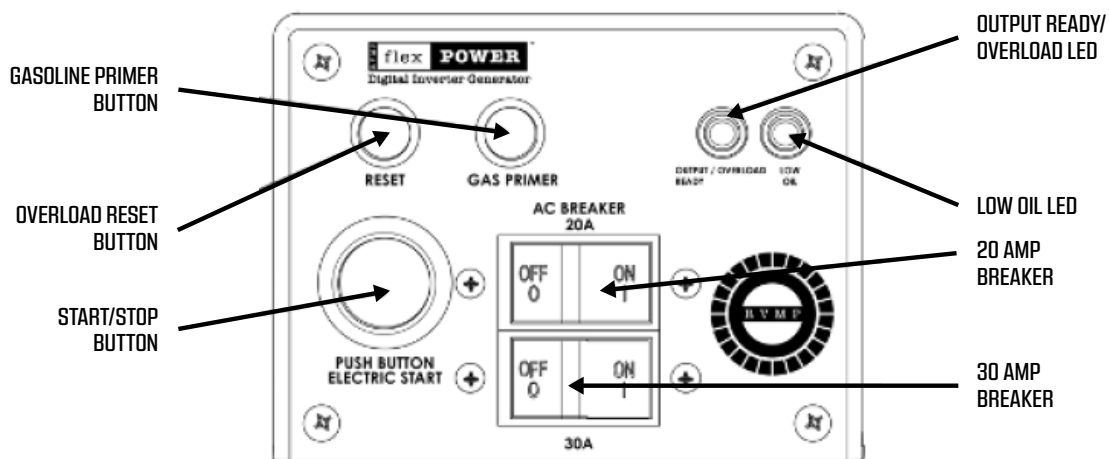

SEC.13 FUEL STATION

A. INTRODUCTION

Your Brinkley RV comes equipped with a fuel station system. This system consists of two separate gasoline tanks, a fuel tank filler, gas pump, fuel gauge, control panel, and a fuel hose with nozzle.

The purpose of the fuel station system is to allow you to safely store gasoline for the use in ATVs, motorcycles, other vehicles, and any other equipment or need while traveling and camping with your RV.

When facing the fuel station, the tank closest to the front of the RV, or to the left, is the GENERATOR fuel tank and the tank closest to the rear of the RV, or to the right, is the ACCESSORY tank. Two tanks are installed so that different fuel types can be stored. The generator fuel tank is plumbed directly to the generator and the accessory tank has a fuel nozzle to dispense fuel as needed. If desired, the fuel in the accessory tank can be dumped into the generator tank using the fuel nozzle of the accessory fuel tank.

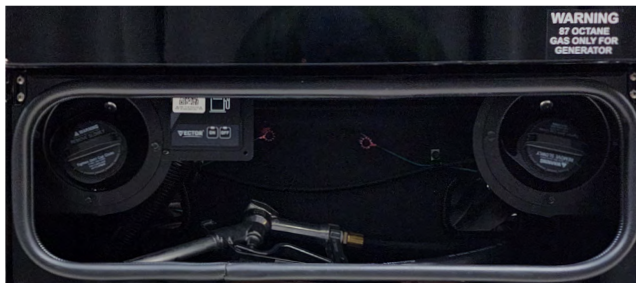

B. GENERAL SAFETY

It is vital to be cautious of your surroundings when utilizing the fuel station. Below are some safety guidelines that should be followed.

- **ALWAYS** turn off all vehicle engines, generators, along with any fuel sourced appliance (i.e. furnace, cook top, water heater, etc.).
- **ALWAYS** turn off the main valve to the LP.
- **NEVER** smoke or light any flame when operating the fuel station or when using the gasoline.
- **NEVER** run any combustion engine longer than needed within a confined space (i.e. closed garage).
- **NEVER** use the provided fuel for anything beyond its intended use.
- **NEVER** prop the fueling latch on the dispenser in the OPEN position.
- **ALWAYS** connect the bonding jumper to help eliminate static electricity. This will help to eliminate the possibility of a static fire.
- **NEVER** overfill the vehicle or equipment fuel tank. This may cause undesired spillage.
- **NEVER** allow children under the licensed driving age to operate the fuel station.
- **ALWAYS** minimize exposure to gasoline fumes and the inhalation of the fumes.
- **NEVER** attempt to siphon the fuel by mouth. Gasoline is very harmful and can be fatal if swallowed.
- **ALWAYS** keep fuel away from skin, mouth, or eye contact. If fuel comes in contact with any surface on your body, immediately rinse the area with water.
- **ALWAYS** remove any fuel-soaked clothing immediately after use.

⚠ WARNING

Before dispensing fuel you should always:

1. Turn all engines and fuel source appliances OFF (this should include any igniters).
2. Connect the bonding jumper wire to the equipment or vehicle receiving fuel.
3. Ensure the RV is properly Grounded.

DO NOT dispense fuel when within 20 feet (6 m) of an ignition source or within 10 feet (3 m) of another motor vehicle or RV. Failure to follow these instructions may result in fire, damage, serious injury, or death.

⚠ WARNING

Gasoline is only to be used for its intended use. It is not to be used to wash your hands or as a cleaning solvent. Using gasoline in this manner may result in damage, bodily harm, or worse.

⚠ WARNING

Never smoke or operate an open flame when using the fuel system. Failure to comply may result in serious injury or death.

C. FILLING THE FUEL TANKS

The fuel tanks on your RV will need to be individually filled, one at a time. As a reminder, the fuel tank to the left, closest to the front of the RV, is the GENERATOR fuel tank and the tank to the right, closest to the rear of the RV, is the ACCESSORY fuel tank.

FILLING THE FUEL TANK:

1. Carefully remove the fuel cap. Opening the cap too quickly can cause fuel to spray out as the pressure is released. The hotter the ambient temperature, the more likely pressure is to build behind the cap.
2. Select the octane grade desired for the tank you are filling.
3. Insert the gas pump's fuel nozzle into the inlet of the RV fuel tank and begin filling.
4. Do not continue to fill once the gas station's pump stops. Overfilling the RV fuel tank may lead to leaks or damage to the fuel system.
5. Reinstall the fuel cap.
6. Make sure all spillage is cleaned up prior to closing the compartment and leaving the gas station.

D. DISPENSING FUEL

In order to dispense fuel, the fuel pump will need to be engaged. This can be performed by pressing the ON button found at the tank monitor. Please see the instructions below for proper operation.

+ NOTICE

Fuel cannot efficiently be dispensed if the tank is under a third (1/3) of the way full and the last 10% of the fuel remaining in the tank cannot be consumed.

1. Ground the RV by connecting the RV to the tow vehicle or by lowering the leveling system to the ground. Properly grounding the RV reduces the possibility of static discharge while fueling an external fuel tank.
2. Turn OFF all fuel fed appliances, generators and engines along with anything that may attempt to ignite.
3. Close ALL vents in the garage area of the RV to prevent fuel vapors from entering the RV.



4. Locate the fuel switch found at the fuel station control panel. If the panel is in Sleep/Locked mode, press either the ON or OFF button. To unlock the panel press and hold the OFF button until the ON feature begins to blink.

SEC.13 FUEL STATION



5. Turn the fuel pump ON. The pump will run for 5 minutes before it cycles OFF. This is a safety feature of the fuel pump. If you are still fueling after 5 minutes, the fuel pump switch will need to be turned ON once more. Continue this cycle until fueling is complete.
6. Locate the fuel hose and nozzle located in the fuel station compartment. Place the tip of the nozzle into the opening of the fuel tank.



7. Begin filling by squeezing the trigger on the fuel nozzle. Be careful not to overfill the vehicle's or equipment's fuel tank. If spillage occurs, clean the area immediately.



8. Once the tank is full, release the fuel handle, return the nozzle to the compartment, and turn OFF the fuel pump switch. Once you turn the pump off, you will hear the pump operate in reverse. This is to empty any remaining fuel found in the hose or dispensing nozzle.



9. After 2 minutes of inactivity, the fuel station control panel will return to the locked mode.

⚠ WARNING

If fuel spillage occurs within the RV, properly ventilate the RV and clean the area with paper towel or cloth. Make sure the cleaning material used is properly disposed of immediately after in a hazardous waste container. Any material becomes flammable with the presence of fuel. Do not place cleaning rags with fuel on them within the RV, other vehicle, or any other area that may be a source of flame. Failure to adhere to this warning may result to damage to your RV, personal injury, or death.

A. INTRODUCTION

Within this section you will find information pertaining to the original audio and video components installed in your RV at the Brinkley RV factory. For additional information, please refer to the manufacturer’s manuals found in the Owner Information Package or visit their website. In the circumstance where an aftermarket modification or installation has been performed on your RV, please contact the servicing Dealer who performed the aftermarket modification or installation work for additional information.



B. AUDIO—ROCKFORD FOSGATE® SOUND SYSTEM

The Brinkley Model Gx is equipped with an amazing sound system. You could be a mobile DJ with the quality of the sound system provided. It is absolutely one of the best sounding stereo systems in the market.

1. Wired Remotes - Punch PMX-1R

Your unit is equipped with a wired remote that provides the various functions and operations of the Rockford Fosgate Sound System. Please refer to the diagram (below) for the buttons schematic.

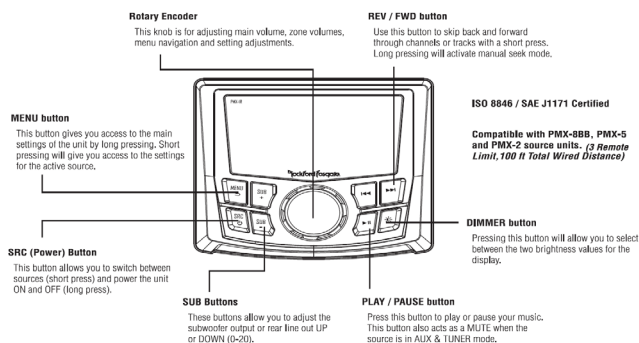

2. Location of the Punch PMX-1R Remote

Main Living Room—Entertainment Center The first location is located near the TV in the living room. Exact location depends on your floor plan.

3. PMX-1R Remote—Features

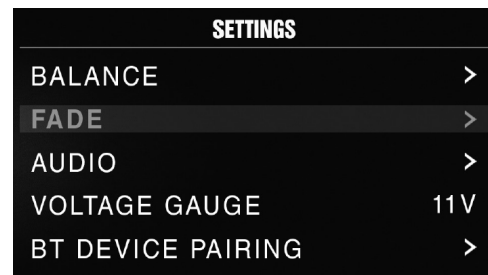

To access the source unit’s settings, long press the **MENU** button until the options appear. Rotate the encoder wheel to scroll through the list of settings and short press the encoder button to select the setting you wish to change. Here is the list of options: **ZONES > BALANCE > FADER > AUDIO > VOLTAGE GAUGE > BT DEVICE PAIRING > BEEP > TUNER REGION > SOFTWARE > PMXCAN > FACTORY DEFAULT**

+ NOTICE

This source unit has a zero current draw when turned off. All of your settings and presets will be saved utilizing your RV’s battery during storage.

- Zones
 - At Brinkley, your Model Gx audio system is set up in 4 zones:
 1. Exterior
 2. Interior—main living area
 3. Interior—garage
 4. Exterior—patio

SEC.14 AUDIO, VIDEO, & CONNECTIVITY

You are able to select any of these 4 zones either simultaneously or individually depending on what areas of the RV you want the audio to play within. If you would like to change or edit zones, please refer to the instructions in the owner's manual by clicking the link or scanning the QR Code below.

4. Basic Operation of the Sound System

- Turning the unit ON/OFF Long press the SRC (Power) button to turn the unit ON or OFF.
- Adjusting the Volume Short press the encoder button to independently adjust the volume for a specific zone (**ZONE ALL > ZONE1 > ZONE2 > ZONE3 > ZONE4**). Rotate encoder knob left or right to desired volume level (0-40). The current volume level will be displayed during adjustment.
- Adjusting the Subwoofer Output Press the SUB + or SUB - buttons to adjust the output level (0-20).
- Adjusting the Screen Brightness—Dimmer Short press the SCREEN BRIGHTNESS button to adjust the brightness level. There are two brightness levels.
- Selecting a Source to Play Short press the SRC button to show the different source options (**FM TUNER > AM TUNER > WB TUNER > USB > AUX1 > AUX2 > BLUETOOTH > PANDORA > SiriusXM > CAMERA**). Use the rotary encoder or short press the SRC button to scroll through sources.
- Selecting a Zone Long press the encoder button to toggle between source zones (**ZONE 1 > ZONE 2 > ZONE 3 > ZONE 4**).

+ NOTICE

When using a USB extension cable, it must be a Rockford Fosgate powered extension cable. The maximum distance for the cable is 33 feet (10 meters).



[RF - PMX-1 Owner's Manual](#)

C. AUDIO/VISUAL SYSTEMS

1. TV Operation—Main Living Area

- a. Turn on the power to the TV.
- b. Select the signal input using the “source” selection on the remote.
- c. Adjust the TV Antenna/Channel Tuning until service is found.

For Philips TV product support, scan the QR codes or click the links above right.



[Philips 6600 TV Product Support](#)



[Philips 4600 TV Product Support](#)

2. TV Signal Booster

To improve antenna reception, the TV Signal Booster must be turned ON.

- The TV Signal Booster works by amplifying all signals to improve the quality of the signal received by the TV.
- To turn the TV Signal Booster on or off, you must locate the antenna connection plate located in the main bedroom, behind the TV, in the ceiling. The button to turn the TV Signal Booster on and off is labeled “ANT POWER.” It is shown in the picture above.
- When viewing cable, satellite, watching a DVD, or playing a gaming system, the TV signal booster must be turned off. The signal booster signal can be picked up by the devices listed above and can cause issues with picture quality.



+ NOTICE

There is also an on and off button located to the right of the coax connection. This button is to turn the Wi-Fi on and off.

3. Cable/Satellite Outlet

Cable and Satellite connection outlets can be located within the water convenience center in the pass-through compartment. The picture below shows the location of the connections.



Connecting COAX for Cable and Satellite:

1. For cable, connect the threaded coax from the source to the “CABLE” connection.
2. For satellite, connect the threaded coax from the satellite dish to the “SAT” connection. Please refer to the satellite manufacturer’s manual for information, instructions, care, and maintenance instructions.

+ NOTICE

A satellite dish is not provided with your RV and is purchased aftermarket.

4. Winegard AIR 360 Lo Profile Operation

AIR 360+ can receive VHF/ UHF/FM frequencies while in a parked position from any direction up to 55 miles away. To watch local TV stations, turn the TV and TV Roof Antenna power on.



- The antenna has 360 degrees of reception so there is no need to aim or point the antenna in the direction of the signal.
- You must run a Channel Scan on your TV to receive maximum programming.
- Ensure the antenna power supply is in the “ON” position and the green indicator light is illuminated. It is located behind the bedroom TV.



ANTENNA POWER SUPPLY

A secondary scan can locate and add any new channels found in your area as well as any channels that have been moved or changed. While the steps to perform a channel scan may vary between televisions or compatible devices, below are some general guidelines to follow:

HOW TO RUN A CHANNEL SCAN USING THE TV REMOTE:

1. Select “Menu” then select “Settings.”
2. Select “Channel Setup.”
3. Select “Antenna” or “Air,” depending on your TV. Make sure you are not on “Cable.”
4. Select “Channel Search” or “Channel Scan.”
 - The steps to perform a channel scan may vary.
 - If the wording on your TV differs from the options shown, refer to your TV user manual for help.
- Running a Channel Scan is NOT the same as pressing Channel UP/DOWN on your remote.
5. To keep your saved channels up-to-date, it is recommended to run a Channel Scan:
 - Once per month.
 - When a channel is lost
 - When you change location

SEC.14 AUDIO, VIDEO, & CONNECTIVITY



5. Vision S+ Camera System

The Furrion Vision S+ Camera System is a standard component installed on your Brinkley fifth wheel. This system includes a back-up camera, two side marker light cameras, and a 7" viewing monitor. This camera system is wired to only have power when the RV is connected to the tow vehicle via the 7-way towing connector. The Furrion Vision S+ Camera System offers a 65 or 140 degree viewing angle, night vision, motion detection, blind spot signal, and auto wake function for extra security when the RV is stationary. Most importantly, it is provided to help you safely transport and back-up your unit. Please read the manual for the Furrion Vision S+ Camera System found in your Owner Information Package prior to downloading or using the Furrion camera. You can also locate the Furrion Vision S+ camera owner's manual on-line at the link or by scanning the QR Code below.



[Furrion Vision S+ Camera
Owner's Manual](#)

6. Starlink Prep Package

(Mobile & Roof Mount Ready)

This isn't just a "prep", it's a complete solution for utilizing your Starlink system, engineered from the ground up based on our customers' feedback.

Dual-Use Solution: Provides two dedicated access points ready for both mobile and roof-mount Starlink systems.

Premium Technology: Features genuine Starlink cabling, not generic wire, to ensure maximum performance and compatibility.

Custom-Engineered Hardware: Includes custom-designed, water-resistant wet bay and low-profile roof ports for easy access and a seamless visual match with Starlink hardware.

Flawless Wi-Fi Coverage: All wiring is strategically routed to a centrally located high point inside your coach, the optimal placement for your router to provide flawless, wall-to-wall, and campsite signal strength and speed.

Scan the QR code or click the link below to watch th Brinkley RV Model G/Gx Starlink Prep Package Video.



[Brinkley RV Starlink Prep
Package Video](#)

A. INTRODUCTION

Within this section you will find information pertaining to the Firefly Control System installed in your RV at the Brinkley RV factory. For additional information, please refer to the Firefly Model Gx Manual at the link or scan the QR Code below. This system is designed to manage only the factory installed equipment on your unit, based on your RV's original specifications. Any aftermarket modifications you make to your unit will work independently of the Firefly System, but will not appear on the Firefly interface.

The Firefly System is integrated with the following systems on your RV:

- Lighting
- Climate Control
- Tank Monitoring
- Awnings
- Slide-Outs
- Leveling
- Bed Lifts
- Electrical System



There are also remote panels in the garage area that will control some of the lighting, the bed lift, and the rear awnings. See image below.



[Firefly Brinkley RV Model G and Gx User Manual](#)

SEC.16 HEATING & COOLING (HVAC)

A. INTRODUCTION

Within this section you will find information on the original heating and cooling (HVAC) components installed in your RV by Brinkley RV. Please know that if any of these components were replaced after the RV left the factory as an aftermarket installation, this information does not apply to those aftermarket items. For additional information, please refer to the manufacturer's manuals found in Owner Information Package or visit their direct website. In the circumstance an aftermarket modification or installation has been performed on your RV, please contact the servicing Dealer who performed the work for additional information.

+ NOTICE

Sufficient power is vital for proper operation and efficiency of the A/C. Insufficient power may lead to damage to your A/C.

B. AIR CONDITIONER WITH HEAT PUMP

The A/Cs within your RV are GE, ducted, 13.5 BTU air conditioners that contain heat pumps. Each A/C can be individually operated and controlled by the thermostat through your Firefly System.

1. Ducted A/C

A ducted RV A/C is similar in setup to an A/C in a residential home. It contains duct work that assists in the deliverance of chilled air to a designated location within the RV. In Model Gx, there are three A/C's installed in the RV; the front bedroom, the kitchen/living room area, and the garage.



[GE Air Conditioner Product Support](#)

2. Duct Work and Return Air

The adjustable registers and vents installed in the RV are designed and intended to **REDUCE** and adjust airflow, **NOT** to fully inhibit airflow. Registers must remain free and clear of any obstruction that may inhibit airflow from passing through the air return. Care should also be taken to ensure that debris and other small items do not pass into the air returns.

⚠ CAUTION

Do not operate the air conditioner without the return air filter. Operation without this filter will allow debris to pass-through and accumulate on the cooling coils. Over time, this will lead to loss of efficiency in cooling, air volume loss, equipment damage, and professional cleaning expenses.

+ NOTICE

Registers should NEVER be fully closed and NEVER fully obstruct the airflow.

3. Heat Pump

Each A/C within your RV contains a heat pump. This feature provides an additional heat source for the RV and is specifically designed to help remove the chill from the RV. Heat pumps can be operated independently or in conjunction with the furnace. In addition to being a heat source, the heat pump also ensure that any ice buildup on the heat exchanger is cleared by periodically cycling to Auto Defrost.

+ NOTICE

For best operation, it is advised not to use the heat pump system when temperatures drop below 28° F (-2.2° C).

4. Cooling vs Heat Gain

The A/C on the RV is designed to cool intake air (outside air) by approximately 15° to 20° F (-9.4° to -6.7° C). Please know that environmental surroundings, the location of your RV, and other conditions may affect the efficiency in performance of the A/C. When located in hot climates with little to no protection to the RV (no trees or surrounding shade), the RV will absorb the heat from the sun and increase the temperature inside the RV. This process is referred to as “heat gain.” Reducing the RV heat gain is important to obtain a comfortable temperature inside the RV. Following the below instructions will help to reduce heat gain within your RV.

REDUCING RV HEAT GAIN:

1. Park the RV in a shaded area with plenty of airflow.
2. Close all the blinds.
3. Keep all doors and windows closed.
4. Extend the awnings to provide additional shade.
5. Avoid the use of heat producing appliances such as the oven or stove top.
6. Set the A/C mode to high. When encountering high humidity or high temperatures, this will help provide maximum cooling efficiency.
7. Turn ON the A/C as early in the day as possible. This will allow the A/C to cool the RV prior the outdoor temperature rising throughout the day.

5. Air Conditioner Gasket

Between the roof material and sub-frame of the A/C, there is a foam gasket that acts as a weatherproof seal. Because the A/C is subjected to wind pressures and motor vibrations, this seal should be inspected every six months.

To inspect the gasket, you must remove the air distribution box located in the interior ceiling in the location of the A/C unit. The photo below shows what the A/C distribution cover looks like for reference. Check for leaks and re-tighten any loose mounting bolts as needed. Be careful to not to over-tighten the mounting bolts. Doing so may result in the seal becoming damaged.



Over time, the A/C gasket will need to be replaced. To gain access to the mounting bolts, the A/C shroud and filter from inside the RV will need to be removed. From there you will be able to carefully remove the bolts and gain access to the seal itself. Please see the manufacturer’s manual for more information and instructions.

C. FURNACE

The Firefly System in the RV controls the function of the furnace. The Firefly interface is located near the main entry door of the RV. For full operation, the furnace requires both 12-volt power and propane gas. Sufficient power is required to properly function the furnace.



[Suburban Furnace
Product Support](#)

SEC.16 HEATING & COOLING (HVAC)

The furnace itself is in the sidewall of the RV on the off door side of the RV and is beside the water heater. The photo below shows the location of the furnace. For additional information pertaining to the operation, maintenance, and troubleshooting of the furnace, please consult the [manufacturer's manual](#).



+ NOTICE

Never attempt to repair a furnace if it is not functioning properly. Furnace maintenance should always be completed by a qualified technician. Only OEM parts are to be used when parts are needed. Inspection and maintenance should be performed on an annual basis, or more frequently if heavily used. Please contact your Dealer with further questions, concerns, or to obtain service.

⚠ WARNING

DO NOT obstruct airflow going to or from the furnace for any reason and do not modify the installation. Doing so will cause unsafe furnace operation and ultimately can lead to damage to the furnace, personal injury, or fire.

⚠ WARNING

DO NOT operate the furnace while slide-out rooms are fully retracted in the closed position. This will prevent proper airflow from occurring and may cause the backup of exhaust and heat resulting in additional wear on the furnace.

D. FIREPLACE

Your RV may have a fireplace (If Equipped) in the main living area. A picture of the fireplace is provided below. The control panel is located in the upper right hand of the fireplace as indicated by the red circle on the photo. These control buttons permit you to change the lighting, heat intensity, and to set a timer so that the fireplace shuts off automatically. The provided remote also provides control of all features.

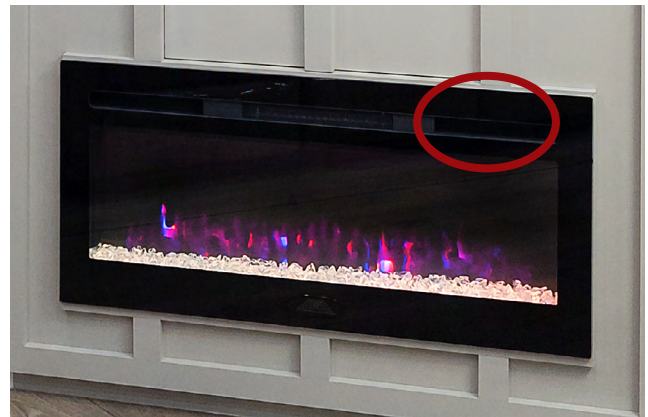

[Furrion Greystone Fireplace Product Page](#)



The Power Button

The power button turns the fireplace on and off. Once on, if the fireplace display is not illuminated, pressing the power button will light up the display. The power button has a built-in memory function that will retain the status of the fireplace when turned off. With the exception of the timer, the fireplace will restart in its previous status. If the fireplace is disconnected from the main power source, it will lose the memory and restart at the default settings.

The Flame Button

Each time the Flame Button is pressed, the colors of the flame and ember bed changes. There are 3 colors (display will show L2, L3 or L4), dynamic condition (display will show L1) that rotates through all of the colors, and the flame OFF setting you that can cycle through.

The Coal Bed Button

Each time the coal bed button is pressed, the color of the rock bed will change. There are four color settings: orange, blue, white, and combination. The timer setting ranges from 30 minutes to 9 hours.

The Heat Button

The heat button turns the heater on and off. When the heater is on, press the heat button until the desired setting is obtained. There are HI and LOW temperature settings that range between 62° - 84° F (17.8° - 28.9° C).

The Timer Button

The TIMER has adjustable setting with range from 30 minutes to 9 hours and OFF. Once you have set the timer, and the timer is up, it will shut off all functions and enter standby mode. In this mode, you must touch the power icon to restart the fireplace.

E. ROOF VENTS

There are three roof vents installed on the RV: one in the rear bath, one in the main living area, and the other in the front bath. These vents are electric and are intended to allow for additional airflow in the RV. Each vent can be operated via a wall mounted remote. This remote is shown below along with a photo of the vent. The location of each remote varies depending on floor plan, but will remain in close proximity of the vent itself.



+ NOTICE

Never leave a vent open while the RV is being stored or for long periods of time. High winds, rain, animals, or other obstructions may cause damage or a leak leading to damage to the RV that may be unwarrantable.



[Maxxair Maxfan Plus Product Support](#)

SEC.17 AWNINGS

A. MAIN AWNING - SOLERA

The Solera® Power Awning installed on the RV is operated by an electric motor and can be controlled by the awning switch found on the remote panel or the Firefly Control System found within the RV. These controls are shown below.



REMOTE PANEL



FIREFLY CONTROL

For full instructions including maintenance and troubleshooting information for the Solera® Power Awning, click on the link or scan the QR Code below for the owner's manual.



[Lippert Solera® Awning
Owner's Manual](#)

The installed awning contains adjustable, friction joint arms rather than traditional locking pivot arms. This allows for easy adjustment and manipulation of pitch when needed. It also helps to prevent damage to the arms during wind events.

⚠ WARNING

Keep clear of any and all moving parts while the awning is in operation. As the awning functions and closes against the unit, there is a risk of being pinched, cut, and crushed.

1. Awning Extension

- Prior to operating the awning, make sure the battery is fully charged and the RV is connected to external shore power. Ensure there are no obstructions preventing the awning from freely retracting.
- Press and hold the EXTEND button to fully extend the awning.
- For partial extension, press and hold the EXTEND button until the awning reaches the desired position. The awning is fully extended when the valance on the awning is pointed downward towards the ground.

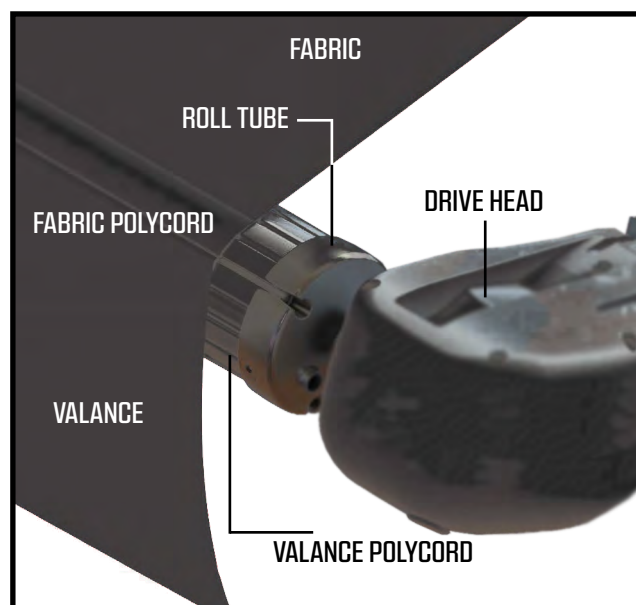

+ NOTICE

Maximum extension is met when the fabric is completely unrolled and taut. When fully extended, the valance seam and a section of the roll tube will be visible and pointing down towards the ground. As soon as this is seen, be sure to stop extension right away. The awning canvas should always be on top of the roll tube rather than under. If the awning is over-extended the awning will begin to retract in reverse and will flip the canvas to the under portion of the roll tube. If this occurs, press the RETRACT button until the awning fully extends and then corrects to retraction.

2. Retracting the Awning

- Prior to operating the awning, make sure the battery is fully charged and the RV is connected to a power source. Ensure there are no obstructions preventing the awning from freely retracting.
- Press and hold the RETRACT button to fully retract the awning.
- For partial retraction, press and hold the RETRACT button until the awning reaches the desired position.

+ NOTICE

The pitch of the awning does not need to be corrected to retract the awning.

⚠ CAUTION

The awning **MUST** be retracted completely during incidents of high wind, heavy rain and/or during any extended time away from the unit. Failure to retract the awning in those instances could cause extensive damage to the awning and unit.

⚠ CAUTION

Do not tie down the roll tubes on the awning. This prevents the free floating, tension arms from functioning as designed. Doing so may result in damage to the awning or to the RV.

3. Pitch Adjustment

If water begins to collect on the awning, the pitch of the awning will automatically adjust to purge the excess water. The auto-dump feature of the awning prevents damage from occurring to the awning and may occur without notice. Adjusting the pitch of an awning will allow water to runoff as it begins to collect on the canvas and can be done by adjusting one awning leg lower than the other.

SETTING THE PITCH

1. Begin by extending the awning to the desired position.
2. Select the side that is most convenient for water runoff.
3. Adjust the leg by pulling downward on the joint until the desired pitch is obtained to allow for proper water runoff to occur.
 - Major adjustments do not need to be made and should be performed on an as needed basis.
 - Never push the joints in an upward motion. Doing so may cause additional stress on the strut causing damage or failure.
 - The bolt and washer on the friction joint allow the arm to remain in the set position.

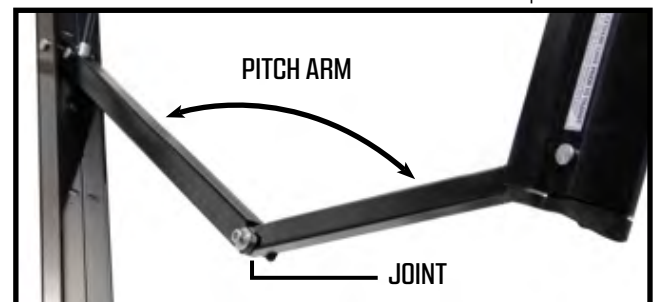

+ NOTICE

If the manipulated arm does not hold in position, tighten the bolt at the joint.

⚠ WARNING

When actuated, the awning arm water dump feature can create a significant load shift. Be sure to avoid grabbing the portions of the mechanism between the pitch arm and the wall mount, or having any part of your body or property in this area.

SEC.17 AWNINGS

B. SLIDE TOPPER AWNINGS – DOMETIC

⚠ CAUTION

PINCH HAZARD. Do not operate the RV slide-out room or Slide Topper if people or objects are in the travel path of the RV slide-out room. Failure to obey this caution could result in minor or moderate injury.

+ NOTICE

Do not close the RV slide-out room or the Slide Topper with leaves, sticks, or other debris on the awning fabric. Damage to the fabric or Slide Topper can occur.

+ NOTICE

If the RV slide-out room is left open during rainy conditions, water may collect on the Slide Topper. This will cause water to spill over the sides as the RV slide-out room closes and the Slide Topper closes.

1. Operation

The Slide Topper automatically opens and closes as the RV slide-out room opens and closes. See [Section 09](#) for information on how to operate the slide-outs on your Brinkley RV.

For full instructions, including maintenance and troubleshooting information for the Dometic Slide Topper Awning, click on the link or scan the QR Code below for the owner's manual.



[Dometic Slide Topper
Awning Owner's Manual](#)

C. REAR PATIO AWNING – GIRARD

Your Model Gx is also equipped with a Girard rear patio awning located above the ramp door. The Thule rear patio awning is operated by a 12V electric motor and can be controlled by the awning switch found on the remote panel located in the garage. A picture of the remote panel is shown below:



1. General Safety

⚠ WARNING

Do NOT modify this product in any way. Modification can be extremely hazardous.

⚠ WARNING

IMPACT OR CRUSH HAZARD. NEVER leave an open awning unattended. Keep awning stowed (closed) when snow, heavy rain, wind, and severe weather conditions are expected. Failure to obey this warning could result in death or serious injury.

⚠ WARNING

IMPACT OR CRUSH HAZARD. Do NOT allow water to pool, snow to accumulate, or heavy debris on awning fabric. Do NOT hang or place anything on awning. The awning will become unstable, and could bend or collapse. Failure to obey this warning could result in death or serious injury.

⚠ CAUTION

PINCH HAZARD. Maintain a horizontal distance of at least 16" between fully open awning and any permanent object. Failure to obey this caution could result in injury.

2. Operating the Awning

- Press and hold the extend button for the awning from the command center located in the garage of the RV. Note that the awning will automatically stop when the extend button is released. This permits you to either fully extend the awning or leave it partially extended.
- To close the awning, press and hold the retract button for the awning from the command center located in the garage of the RV. Prior to transit, the awning must be fully retracted.

3. Manually Overriding the Awning

In the event that you lose power to the RV or the awning motor on the rear patio awning does not function, you can manually override the awning. When facing the rear of the unit, the manual override is located on the side of the awning opposite the motor. If you have a right hand motor (shown below) the override will be on the left hand side and vice versa.

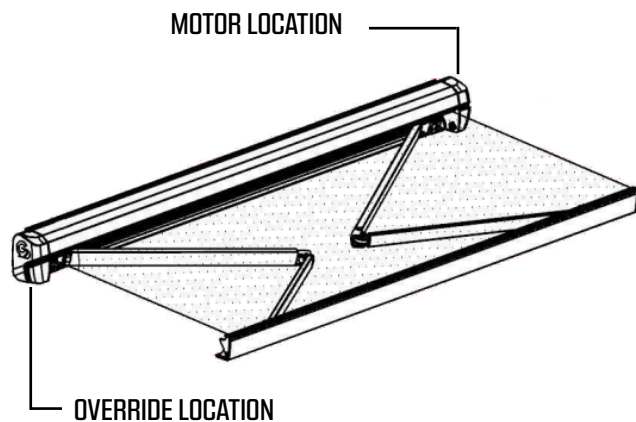

- Remove the end cap opposite the motor, by removing the 3 Philips head screws.
- Using a 13mm wrench, turn the manual override shaft in order to close the awning.

+ NOTICE

The manual override is one-way, it can only close the awning.

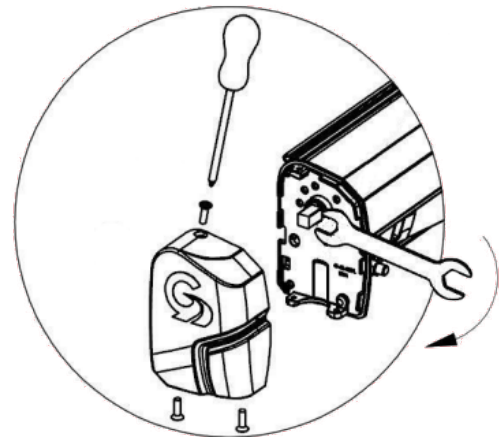

- Contact your Dealer or an approved service facility to inspect the awning and resolve any issues if the awning failed to operate and the unit still had power.

4. Maintenance of the Awning

The Girard Owner's Manual does not call out maintenance instructions. That said, the awning fabric and components are comprised of similar materials to that of the main awnings and slide topper. Please refer to the maintenance instructions for the main awnings or slide toppers for maintenance guidance. Click on the link or scan the QR Code below for the Girard Patio Awning owner's manual.



[Girard Patio Awning Owner's Manual](#)

SEC.18 APPLIANCES

A. GENERAL INFORMATION

Before using any appliance in the RV, it is best to read and understand all instructions, warning, and safety alerts provided within the manufacturer's manual of each appliance. These manuals can be found within your Owner Information Package. If you happen to have additional questions or concerns, please do not hesitate to contact your Dealer or Brinkley RV Customer Care. In the circumstance where aftermarket modifications have taken place within the RV, the provided instructions within this manual may not apply. In this occurrence, please contact the service center who performed the aftermarket installation for additional information and assistance.

B. MICROWAVE

To utilize the microwave, sufficient 120-volt power MUST be available or the inverter must be used. To prevent damage, ensure the glass turntable within the microwave is properly secured before traveling. In RV's that do not have a range hood, the microwave vent is utilized in place of the range hood.



[GE Microwave Product Support](#)

C. 120-VOLT REFRIGERATOR

The refrigerator installed within your RV is 18.6 cubic feet (0.53 cubic meter), 120-volt refrigerator. For best cooling results, it is best to stock the freezer with already frozen foods and cold items within the main compartment.



[GE Refrigerator Product Support](#)

- Stock the freezer with already frozen foods.
- Place chilled items in the cooling compartment.
- Arrange food so air can still circulate.
- Never cover the shelves with materials (i.e., cloth, paper, plastic, etc.).
- Keep the back section of the refrigerator clean and free of clutter, spills, and debris.
- Regularly have the refrigerator inspected and repaired as needed.
- At a minimum, the refrigerator should be inspected bi-annually.
- Repairs should always be performed by a certified or authorized service provider.

REFRIGERATOR SECUREMENT It is important to remember to always secure the refrigerator doors with the supplied velcro straps prior to travel. Failing to do so may result in damage to the refrigerator doors, loss of temperature and spoilage of food, and/or damage to the interior of the RV.

To utilize the travel securement, you will need to first wrap the velcro strap around the french door handles and ensure the grip on each end of the strap is secured to one another. Then, insert the second strap through the grommet on the first strap, around the freezer handle, and loop the receiving end of the second strap around the knob. Please see the photos below demonstrating how this is performed.



D. COOKING WITH PROPANE

IF YOU SMELL PROPANE:

1. Extinguish all open flames, pilot lights, smoking materials, etc.
2. Refrain from touching any electrical switches.
3. Shut off the propane supply to the LP bottles.
4. Ventilate the RV by opening all doors, windows, and vents.
5. Remain at a safe distance from the RV until all odor clears.
6. Have the propane system inspected and repaired as needed before continuing use.

Failure to comply with these instructions may result in explosion of the RV leading to serious injury or death.

⚠ DANGER

Never use portable fuel operated cooking equipment inside the RV (i.e., portable grills, stove tops, etc.). Use may lead to the build-up of carbon monoxide, inability to properly breathe, damage, personal injury, and fire.

Grease Fires

Grease is highly flammable. Always clean the burners on your cook top so grease does not collect on the surface or around the burner. If grease is spilled, clean it up immediately before continuing to cook. If a fire ignites, the instructions on the following page should be followed.

IF THERE IS A GREASE FIRE:

1. Evacuate the RV immediately and make everyone is accounted for. Have everyone remain at a safe distance until the fire is extinguished.
2. Once everyone is at a safe distance, safely attempt to extinguish the fire.
 - First eliminate the fuel source by shutting off the oven or burner.
 - Attempt to smother the fire with a cooking lid.
 - Extinguish with baking soda or a multipurpose dry chemical extinguisher.
3. Never pick up a flaming pan. This can cause the fire to quickly spread if the pan is dropped or if the grease is spilled.
4. If the fire cannot be easily extinguished, your safety is priority. Immediately return to a safe location that is clear of the RV and call 911 to have the Fire Department handle the emergency.

SEC.18 APPLIANCES

E. OUTDOOR COOK TOP (IF EQUIPPED)

The outdoor cook top will only be found on select models, typically those with a bunk house.

WHEN USING THE OUTDOOR COOK TOP:

- **NEVER** leave the cook top unattended.
- Small children and pets should **ALWAYS** remain at a safe distance.
- **NEVER** store or place flammable materials or liquids near the lit cook top.

After use: Allow the cook top to fully cool prior to storing in the closed, travel position.

⚠ WARNING

Never cover the vent openings on the oven while the cook top is in operation. Restricting airflow will create an asphyxiation hazard.

⚠ WARNING

During and after use, while the burners are still hot, **DO NOT** touch or allow flammable materials to come in contact with the top burners, the burner grates, or any other surface that may be hot. Failure to do so may result in personal injury, damage, or fire.

⚠ WARNING

Before using the outdoor cook top, the vehicle **MUST** be level and stabilized. All instructions and warnings within the manufacturer's manual must be followed at all times. Do not store the cook top until it is fully cooled. Failure to follow these guidelines may lead to damage to the RV, fire, or explosion resulting in personal injury or death.

⚠ DANGER

NEVER USE GAS OPERATED COOKING APPLIANCES IN ATTEMPT TO OBTAIN HEAT FOR COMFORT. This form of use may lead to carbon monoxide poisoning, resulting in sickness, serious injury, or death.

F. OVEN

The oven utilizes propane gas. Never store items in the oven, even when it is not in use. For additional information and warnings, please see the manufacturer's manual. Also See [Section 19H](#) on the next page.

G. RANGE HOOD (IF EQUIPPED)

The range hood has both a light and fan control switch on the front panel. The 8" x 8" (20.32 cm x 20.32 cm) aluminum mesh grease filter (located on the underside of the range hood) can be gently hand-washed using mild soap and water. In cases where there is no range hood, the microwave vent acts as the range hood.

⚠ WARNING

NEVER leave cooking food unattended. Turn pan handles inward, but not over the tops of the other range burners. Ensure that pans used are large enough to contain the food and avoid boil-overs. Heavy splattering or spills left on the cook top can ignite and cause burns.

H. RANGE TOP WITH OVEN

When selecting pan sizes, please refer to the manufacturer's recommendation. By following the recommended pot and pan sizes, you will improve cooking efficiency, lessen the risk of injury, and lessen the risk of damage. The pan should be large enough to cover the burner range, but no more than one inch larger than the burner grate itself.



[GE Range Top with Oven Owner's Manual](#)

I. WASHER / DRYER PREP

Your RV is prepped for an aftermarket RV-rated washer/dryer (Customer Supplied) in two separate locations: the master bedroom and in the garage of the RV. A residential washer and dryer should never be used in a Brinkley RV.

Both washer/dryer prep locations are designed specifically for the stackable Splendide branded washer/dryer that is 23-½" (59.69 cm) wide. The ventless version is required for the garage prep.

1. Master Bedroom Prep

The first prep station is in the front cabinet just to the right of the closet in the master bedroom. Please know that this space is specifically designed for the installation of an aftermarket RV-rated washer/dryer. Please see the below photo.



The clothes hanging rods and the shelves in this cabinet are removable to permit installation of the washer/dryer. Upon installation both will need to be fully removed. Below is a photo of the water connections in the master bedroom.



2. Garage Prep

The second prep station is in the rear portion of the RV in the garage. The water inlet is located near the garage monitor panel. This space is designed for an aftermarket RV-rated washer and a vent-less RV-rated dryer. There may be a cover over the prep station. Please see the photos below.

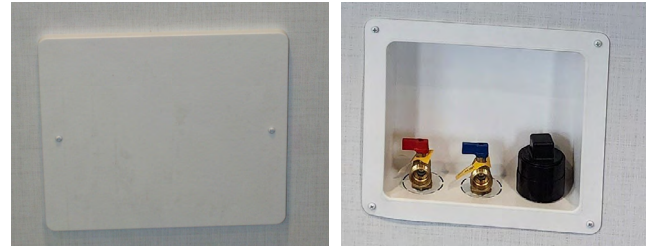

Because there is no exhaust for the dryer in the garage, if installed in this location, a vent-less dryer MUST be used. Please contact your Dealer or appliance manufacturer for additional information and installation assistance.

J. DISHWASHER PREP (IF EQUIPPED)

Your RV is prepped for an aftermarket RV-rated dishwasher (Customer Supplied) in the kitchen under the sink. A residential dishwasher should never be used in a Brinkley RV. The recommended dishwasher to purchase for this installation is the Edgestar DWP63.



SEC.19 PROPANE (LP) SYSTEMS

A. GENERAL INFORMATION

The propane system within the RV includes all gas related appliances, propane cylinder(s), propane regulator, and all plumbing going to and from the LP cylinders to the appliances. Please see all the related manufacturer's manuals for additional information, instructions, and safety precautions.

B. MAINTENANCE

Although the propane system is carefully inspected by both Brinkley RV and your selling Dealer, the propane system should continuously be inspected and repaired as needed. While in transit, fittings can loosen due to the vibration of the RV being towed or moved.

As a safety precaution, the RV's propane system should be inspected immediately upon purchase, after LP tanks are initially filled, and after the first 5,000 miles (8,046.72 km) traveled. Continuous LP inspections are part your normal RV maintenance and should be completed on an annual basis by your Dealer or a qualified service technician.

DO NOT REMOVE THE FOLLOWING LABEL FROM YOUR RV:

<p>⚠ DANGER</p> <p>ALL PILOT LIGHTS, APPLIANCES AND THEIR IGNITORS (SEE OPERATING INSTRUCTIONS) SHALL BE TURNED OFF BEFORE REFUELING OR FUEL TANKS AND/OR PROPANE CONTAINERS. FAILURE TO COMPLY COULD RESULT IN DEATH OR SERIOUS INJURY.</p>
<p>⚠ WARNING</p> <p>DO NOT FILL PROPANE CONTAINER(S) TO MORE THAN 80 PERCENT OF CAPACITY. FAILURE TO COMPLY COULD RESULT IN A FIRE OR PERSONAL INJURY.</p>
<p>⚠ CAUTION</p> <p>THIS PROPANE PIPING SYSTEM IS DESIGNED FOR USE WITH PROPANE ONLY. DO NOT CONNECT NATURAL GAS TO THIS SYSTEM.</p> <p>Securely cap inlet when not connected for use. After turning on propane, except after normal cylinder replacement, test propane piping and connections to appliances for leakage with soapy water or bubble solution. DO not use products that contain ammonia or chlorine.</p>

C. PROPANE GAS

Propane (also referred to as LP) is widely used within your RV by appliances including, but not limited to, the stove, cook top, furnace, and water heater.

Ethyl Mercaptan, an unpleasant chemical with the odor of "sulfur or rotten egg," is added to propane as a warning agent. Upon smelling this odor, it should alert you that LP is present and there is a possible leak creating a safety hazard.

When an LP tank is low in fuel, you will notice a different odor, one more like onion or garlic. As soon as the tank is refilled, this smell will dissipate. Commonly, this odor is mistaken as a gas leak. Be cautious of this and try to be aware of the different smells present with LP.

If you notice the odor persists, turn OFF all the gas operated appliances, shut the LP tank valves, and contact your Dealer or a qualified service facility to inspect the LP system.

⚠ DANGER

IF YOU SMELL PROPANE:

1. Extinguish all open flames, pilot lights, smoking materials, etc.
2. Refrain from touching any electrical switches.
3. Shut off the propane supply at the LP bottles.
4. Ventilate the RV by opening all doors, windows, and vents.
5. Remain at a safe distance from the RV until all odor clears.
6. Have the propane system inspected and repaired as needed before continuing use. Failure to comply with these instructions may result in explosion of the RV leading to serious injury or death.

D. PROPANE GAS CYLINDERS

1. General Information

Propane cylinders, commonly referred to as LP bottles, are utilized for the storage and delivery of propane gas (LP) to the LP operated appliances within the RV. It is required for all propane cylinders to be filled at a qualified propane fill station and are filled by weight. While under pressure in the LP cylinder, the LP is in liquid form. As propane is released from the LP cylinder, it immediately transforms back into a gaseous state before reaching an appliance. The state of the LP is managed by an LP regulator found within 24 inches (60.96 cm) of the LP cylinder.

⚠ DANGER

Propane EXPANDS 1.5% for every 10° F (5.56° C) increase in temperature. Sufficient space within the LP cylinder must be left to allow for the expansion of gas during warmer weather. Failure to leave sufficient space may result in the cylinder exploding leading to property damage, RV damage, personal injury, or death.

While the propane system is not in use, the propane cylinder valves **MUST** be closed to keep LP from being released. To fully shut off the LP, turn the valve found at the top of the propane cylinder clockwise. To open the LP valve, turn the valve counterclockwise. LP cylinder valves should always be hand tightened. Tools should never be used when opening or closing the LP cylinder valves. Over-tightening this valve may lead to damage of the internal seal which will cause them to improperly seat. If the seals are incapable of seating correctly, the valve will not be able to properly close and as a result will allow LP to bypass.

The LP cylinders provided with the RV are DOT (Department of Transportation) Cylinders. Every DOT cylinder is equipped with an overfill protection device (OPD) and Acme Type 1 propane connector.

Also, the valve can easily be identified by its triangular knob shape. Before traveling with or storing the RV, ensure this valve is fully closed on the tank.



LP VALVE



ACME TYPE 1
PROPANE CONNECTOR

When removing the cylinders to fill, always reinstall them in the proper orientation. Typically, DOT cylinders have an arrow and label signifying “top” to indicate the correct orientation of how the cylinder(s) should be installed.

+ NOTICE

LP cylinders should always be mounted, stored, and transported in the correct specified position. They should be securely fastened using the straps provided by Brinkley RV.

Each LP cylinder is connected by a thermal Type 1 Acme Pigtail. You will also find a two-stage regulator to monitor the pressure of LP released. The pigtail assembly is a wrench-less system and should only be hand tightened when needed.



TYPE 1 ACME PIGTAIL

⚠ WARNING

Because propane can quickly expand, a pressure release valve is installed on the cylinder so that gas can discharge as pressure builds. If gas is discharged, it will be released into the surrounding environment. Propane cylinders should never be stored indoors or inside the RV.

2. Servicing or Filling

Upon purchasing the RV and as the tanks are filled, the propane system should be inspected for leaks.

⚠ WARNING

When filling tanks, only the qualified service representative should be near the RV. Make sure all parties are at a safe distance and not within the RV.

When an LP cylinder is being filled for the first time, make sure a qualified representative purges the cylinder of any trapped air. If the cylinder is not purged, an imbalanced mixture of air and gas may occur making it impossible for propane appliances to light.

⚠ WARNING

PRIOR TO arriving at a propane fill station, be sure all pilot lights are fully extinguished and all LP appliances are shut off. Always turn off the engine of the tow vehicle before fueling. Never smoke or operate other ignition sources while fueling.

3. LP Gas Container Overfill

⚠ WARNING

If you suspect an LP cylinder has been over-filled, remain at a safe distance and contact your Dealer or a qualified propane technician immediately for assistance. Never attempt to service an over-filled LP cylinder.

4. Propane Leak Test

Test for leaks with a water and soap solution.

TESTING FOR LP LEAKS:

- Mix the solution and spray all joints and fittings of the gas line.
- When a leak is present, the soapy solution will bubble.
- Small bubbles tend to indicate smaller leaks and larger bubbles indicate larger leaks. Neither should be ignored.

+ NOTICE

Never use an ammonia or chlorine-based solution. Both can cause corrosive damage to the gas lines and fittings.

⚠ WARNING

Never use an open flame to test for leaks. Doing so may result in fire or explosion leading to serious damage, injury, or death.

5. Propane Gas Alarm

Each RV is equipped with a Propane Gas Alarm. Please See [Section 4G](#) for additional details. Please also refer to the manufacturer's manual.

⚠ DANGER

The Propane Gas Alarm should be tested before every use of the RV and at least once a week throughout the trip.

⚠ WARNING

Never remove power from the alarms to silence them.

6. Installing the Propane Cylinders

Correct positioning of the LP cylinder(s) and all related hoses and fittings is vital for the proper operation and flow of propane.

INSTALLING LP CYLINDERS:

- **ENSURE** all fuel fed appliances are shut **OFF**.
- **ENSURE** the LP cylinder valve is **CLOSED**.
- **CONNECT** the 3/8" low-pressure hose to the inlet of the two-stage regulator.
- **PLACE** the LP cylinder on the LP bracket in the designated compartment and secure the tank in place using the provided straps.
- **MOUNT** the regulator on the back wall centered to the compartment so the vent is pointing downward.
- **ATTACH** the Type-1 pigtail hose to the regulator and hand tighten.
- **ATTACH** the main supply hose from the regulator to the brass manifold fitting in the frame of the RV. The swivel brass nut on the main hose will be your final attachment.

⚠ WARNING

To prevent tension and strain, a 12-18" (30.48-45.72 cm) Type 1 Acme Pigtail must be installed. Keep the pigtail hose free and clear from sharp edges and objects.

REINSTALLING AN LP CYLINDER:

- Inspect and tighten fittings as needed. Use the soap and water solution to test.
- Slowly open the main shut-off valve on the LP cylinder to prevent the propane from freezing up.
- If the propane freezes up, immediately close the main LP valve and wait at least fifteen (15) minutes before attempting a second time. For more information, please refer to the regulator manufacturer's manual.
- Listen for a hissing sound as the main valve is opened. If this sound last longer than a second, quickly shut the valve. This is an indication that there may be a leak. If you suspect a leak and it cannot be found, contact your Dealer or a certified service location for assistance.
- **REINSTALL** all protective covers and caps that were removed from the LP system.

⚠ WARNING

Ensure that all fasteners and safety straps are secured before traveling.

E. PROPANE REGULATOR

Installed within the LP compartment on the off door side, or driver side, is a dual two-stage automatic regulator. The purpose of this regulator is to reduce the pressure of the LP coming from the LP cylinders to a consistent and safe pressure as well as allow the convenience of switching from one LP cylinder to the reserve LP cylinder when empty.

The first stage of the regulator reduces the LP pressure down to 5-10 psi (34.5-68.9 kPa). The second stage of the regulator further reduces the pressure to an operating pressure of 11" (27.94 cm) W.C. (water column).

For efficient performance, the second stage of the regulator should be adjusted by your Dealer or qualified service representative using a calibrated manometer.

- When the pressure is too high, safety and performance will be affected within the LP system.
- When pressure is too low, the operation of the LP appliances will be affected and may not operate or operate correctly.

If your RV contains an automatic two-stage regulator and both LP cylinders are full, turn the lever found on the regulator towards the LP cylinder you would like to use first. The chosen LP cylinder will be the primary tank utilized and the other will be the reserve.

Once the primary LP cylinder is determined with the regulator lever, slowly open the LP cylinder valve. The indicator found at the top of the regulator will change to green as the LP makes its way to the regulator. Once the primary LP cylinder becomes empty, as long as the reserve cylinder valve is open, the regulator will slowly begin to pull from the reserve tank. At this point, the indicator will show red signaling that the cylinder the lever is facing, is empty. At this time, the regulator lever should be switched over to the reserve LP cylinder.

The indicator will turn green as the LP supply increases in pressure. At this point, the empty LP cylinder can be removed and filled without interrupting the flow of LP from the reserve cylinder.



After the LP cylinder is refilled, remember to reconnect the pigtail line and secure the LP cylinder with the provided straps. If you would like notice before the regulator begins to pull from this cylinder, leave the valve closed. This will prevent the regulator from switching to the opposing LP cylinder without notice.

+ NOTICE

When the indicator on the LP regulator is RED, the LP tank is empty. If the indicator is BLACK, LP is still being supplied.

⚠ WARNING

Vibration from travel can cause fittings to loosen over time. Frequently inspect the LP system for leaks and loose fittings. Failure to inspect the LP system may lead to gas leak resulting in fire or explosion.

⚠️ WARNING

When a two-stage propane regulator is installed, it must be installed with the regulator vent facing down. Regulators found outside of the storage compartment are equipped with a protective cover. These regulators must also be installed with the vent facing down and the cover must remain in place to help minimize the possibility of the vent becoming blocked. If these instructions are not followed, vents may lose their efficiency or become obstructed leading to the buildup of excessive gas pressure and may cause fire or explosion.

F. PROPANE SYSTEM COMPONENTS

The hoses, pipes, tubes, and fittings that comprise the propane system are designed to handle pressures exceeding what the overall propane system is designed and intended to handle. The purpose of this is to provide additional safety within the overall LP system.

Because components will deteriorate over time, particularly when exposed to the elements, all components should be continuously inspected for wear and tear as suggested. LP hoses should be inspected prior to every use for cracks, durability, and flexibility. If cracks are present or durability and flexibility has been lost on the line, refrain from using the LP system until the line can be replaced.

When replacing an LP line or component, do so with components of the same nature, type, and rating. Never replace components with substitutions not suitable for the LP system. Always verify components with your Dealer if you are not sure.

The fittings utilized within the LP system connect all the various components found within the system. The fitting found at the end of the propane supply hose is made of brass and is known as a POL fitting.

The threads within the fitting are left-handed threads which means you would turn counterclockwise to tighten, and clockwise to loosen. The nature of this fitting allows it to prevent leaks from occurring without the use of pipe sealant and is designed to reduce the flow of LP in the event the regulator fails or hose malfunctions.

G. COOKING WITH PROPANE

Because an RV is much smaller than a typical house, oxygen within the RV is limited. Any time a LP appliance is used within the RV, such as a cooking appliance, the RV should be properly ventilated to avoid the danger of asphyxiation.

H. TRAVELING WITH PROPANE

PRIOR TO TOWING THE RV:

- **ENSURE** the propane cylinders are properly seated and fastened with the supplied straps.
- **SHUT OFF** all LP fueled appliances.
- **CLOSE** the valve found at the top of the LP cylinder.

Make sure you know the local laws regarding LP systems and transportation. State laws vary depending on location (i.e., tunnel and bridge laws when traveling with LP). Know this information before traveling in that given state.

⚠️ WARNING

NEVER operate the propane system while the RV is in motion. Unpredictable weather conditions may pose great threat to the LP system if the provided instructions are not followed. For example, wind currents may cause flame reversal in the water heater or cooking appliance which could lead to fire or explosion.

I. OPERATING THE PROPANE SYSTEM

Once the RV is fully set up and prepared for camping, please refer to the following steps for proper operation of the LP system.

OPERATING THE LP SYSTEM:

- **ENSURE** all burners, controls, and pilot lights are shut off.
- **OPEN** the main valve on the **LP cylinder SLOWLY** to prevent an LP freeze-up from occurring. If a propane freeze-up occurs, immediately close the valve and wait at least 15 minutes and then try again.
- **LISTEN** carefully as you open the valve and as propane begins to flow. If the hissing sound of LP rushing through the lines lasts more than a second or two, quickly shut the main valve and contact your Dealer. In this occurrence, most likely there is a leak.
- **OPERATE** the LP appliances **ONLY** as directed in the appropriate manufacturer's manual.

+ NOTICE

About LP Freeze Ups: As the liquid propane expands to a gas form and reaches its boiling point, it commonly freezes the available humidity around the regulator. This form of freezing isn't cause for concern. However, in extremely rare cases, the propane can "freeze" and remain in a liquid state as it passes through the regulator.

Prior to operating the propane system, please read and understand all instructions, safety requirements, warnings, and labels found within this document and the provided manufacturer's manuals found within the Owner Information Package.

If you have additional questions or concerns, please contact your Dealer, the component manufacturer, or Brinkley RV Customer Care.

J. CALCULATING PROPANE USE

To determine how long the propane supply will last on your RV, use the BTU rating for each LP appliance. Propane consumption will vary depending on the length of use and the BTU used by the component. To calculate supply, take the BTU remaining in the LP cylinder divided by the BTU of the given appliance.

As reference, each gallon of propane (3.79 liters) produces roughly 91,500 BTUs of heat energy. If the furnace uses 16,400 BTU/Hr. and the LP cylinder has one gallon of propane, the calculation would be as follows: $(91,500 \text{ BTU}) / (16,400 \text{ BTU}) =$ approximately 5-1/2 hours of use.

$$\text{(Gallons of Propane x 91,500 BTU) / Appliance BTU = Supply of BTU in Hours.}$$

Many of the LP appliances operate intermittently to prevent over-consumption of fuel. For example, unless the water heater is heavily used, the consumption of LP by the water heater is minimal. Be aware that cold weather and high winds can increase LP consumption of the gas appliances.

APPLIANCE	AVERAGE BTU CONSUMPTION/HR.
WATER HEATER	60,000 (RUNNING WATER THE WHOLE HOUR)
FURNACE	6-12 AMPS
RANGE W/OVEN	7,100
RANGE – REAR BURNER	6,500
RANGE – FRONT BURNER	9,000

A. INTRODUCTION

There are two water systems provided in the RV:

1. The Fresh Water System
2. The Wastewater System

The Fresh Water System

Includes the freshwater holding tank(s), freshwater PEX lines and fittings, water heater, water pump, exterior spray ports, faucets, and water purification system (If Equipped).

The Wastewater System

Consists of the gray and black water holding tanks, drains, drain lines, and toilet. Prior to each trip and before the RV is stored, the following items should be inspected for leaks:

- All fresh and wastewater system lines and fittings.
- All faucet connections and its draining system.
- The water pump and water heater plumbing and connections.

At the end of each trip, the fresh tank should be drained and the waste tanks, both gray and black, should be properly emptied.

DO NOT REMOVE THE FOLLOWING LABEL FROM YOUR RV:

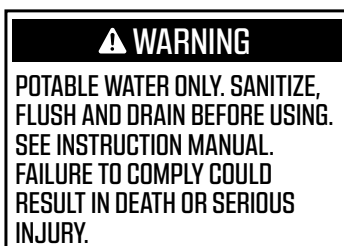

WARNING

Do not drink or consume water of unknown quality or that is deemed unsanitary or unsafe.

B. FIRST USE OF THE FRESH WATER SYSTEM

If your RV has been winterized from the factory, there will be a label placed on the entry door signifying “This Unit Has Been Winterized.”

**THIS UNIT HAS
BEEN WINTERIZED**

Even if the RV has not been winterized, the water system should be sanitized prior to the first use. Sanitizing the water system in the RV will kill unwanted bacteria and organisms that may contaminate the water supply.

Please know that small amounts of contaminants and minerals are found in all water supplies. Even small amounts of contaminants can cause the freshwater to have an odor over time.

Please See Section 200 for instructions on how to sanitize the Fresh Water system.

C. TANK MONITORING

The Firefly System Panel

Located just inside the main entry door in the hallway leading to the bedroom and bathroom. This system provides control to many of the functions within the RV such as your slides, heating, cooling, lights, fuel, battery voltage, while also providing fill levels of all holding tanks on your RV.

D. WATER PRESSURE REGULATOR

Some RV parks, especially those in mountainous regions, have excessive water pressures that exceed the pressure limits of what the RV water system is capable of handling. If the RV is not properly protected, the water system can be compromised and/or damaged. To prevent damages, it is recommended you purchase a water pressure regulator. This is a **Customer Supplied** item and can be purchased through your Dealer.

+ NOTICE

Excessive water pressures may cause the O-rings within the water system to fail if a water pressure regulator is not used. It is recommended for a water pressure regulator rated at 45 psi (310.3 kPa) be utilized when filling with or otherwise utilizing city water. This is a Customer Supplied item and is not supplied with the RV.

E. WATER PUMP SWITCH

The water pump can be turned on by the Nautilus P4 - 3 Handle system panel or the Firefly system panel. Once the water pump is turned ON, it will run until there is 45 psi (310.3 kPa) within the waterlines. Once the pump achieves a pressure of 45 psi (310.3 kPa) it will automatically shut off. The water pump is an on-demand pump and will run anytime the pressure in drops below 45 psi (310.3 kPa).

F. 12-VOLT WATER PUMP

The water pump is located in the pass-through storage compartment behind the access panel and behind the filtration system. Once the on-demand water pump is activated, it will self-prime and provide water. It will continue to run even after the water is shut off until it builds approximately 45 psi (310.3 kPa) of pressure within the waterlines. The water pump contains a built-in check valve that will not allow water to back flow and will automatically restart if pressures drop within the water lines. The water pump filter (If Equipped) is a reusable screen-type filter that is located on the inlet side of the fill. This filter should be periodically cleaned as needed.



[SeaFlo Water Pump
Product Support](#)

G. WATER FILTRATION SYSTEM

Just before the water reaches the 12-volt water pump, the water is filtered through a single stage filtration system. The purpose of this filtration system is to remove unwanted containments such as iron and sulfur while also removing possible smells from the harsh water found at many campgrounds. This filtration system is located in the pass-through storage compartment, behind the collapsible access panel, near the water pump. The initial filtration system flow rate throughout- 2.64 GPM/10 LPM range at 45 psi/0.31 MPa incoming pressure. The flow rate decreases as the filter does its job and becomes clogged with the trapped impurity. The rate of decrease varies by water quality from place to place. When the flow rate decreases noticeably, it is time to replace the filter to maintain optimal water quality and the best user experience.

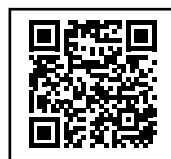

[CLM Products Water
Filtration Product Support](#)

H. FRESH WATER HOLDING TANK

To fill the freshwater tank, do so using the freshwater inlet referred to as the city water inlet. The picture (below) shows the city water inlet (circled in red).



+ NOTICE

When filling the fresh holding tank, do so with caution and DO NOT leave the tank unattended while filling. It is important to never overfill the tank. When a tank is overfilled, it causes excess pressure to build within the tank that may lead to leaks and water damage. Such damages are unwarrantable and can be costly.

Under the RV, you will notice plastic overflow tubes that are directly plumbed into the freshwater tank. See picture, below.



The purpose of these lines is to alleviate pressure as it is built within the tank, or to prevent the tank from overflowing when being filled. On occasion, you may see water being expelled from these lines if the tank is overfilled, the RV is parked on an incline, or when from stopping and starting while traveling. This is normal and should not pose a concern.

- **NEVER** block, cap, or modify the overflow tubes in any way.
- When the overflow tubes become obstructed, water pressure can build while filling and can cause damage to the plumbing system.

+ NOTICE

Freshwater supply should be disconnected when the RV is left unattended for extended periods of time. This will limit the damages if there are leaks within the water system.

SEC.20 PLUMBING SYSTEMS

I. WATER HEATER—TANKLESS

1. General

Before using the hot water heater, please read all safety and operating instructions, information, and warnings provided within this manual and the manufacturer’s manual. The tankless hot water heater installed within the RV is an on-demand water heater. As hot water is used, the tankless water heater will heat incoming cold water through a coil system. This temperature is regulated by an internal sensor over a large heat exchanger. This design allows the hot water heater to operate with energy efficiency unlike most conventional tank water heaters that require constant energy during the re-heat cycles. Following is a photo of the front cover plate of the water heater.



2. Controller Operation

Before normal operation of the appliance, perform a basic functional test each time the RV and water system is set up for use. Refer to “Initial Startup” of the component manufacturer’s manual for instruction. After the functional test is completed, the appliance can be operated from the controller located under the main bathroom sink. A photo is shown above right.

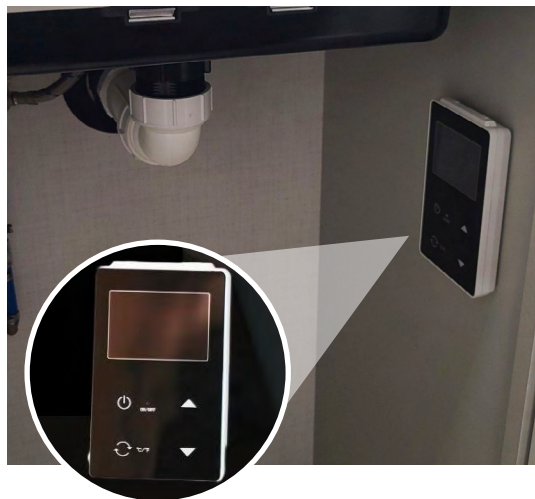

- Touch the power button to turn the power ON/OFF. Upon pressing the power button, the panel and screen will illuminate and display the current temperature setting.

+ NOTICE

The microprocessor is always on. It draws approximately 0.25 amps.

- Touch button marked “°F/°C” to transform the temperature display in °F or °C, the related LED would be lighted on the controller.
- Touch the up or down buttons to adjust the temperature to your desired settings. The wall controller settings range from 95° F (35° C) to 123° F (51° C).



[RVMP flexTEMP Water Heater Owner's Manual](#)

⚠ WARNING

Gas combustion consumes a large amount of air and generates hot exhaust gases including carbon monoxide as the appliance works. Harm or even death may be caused by inhalation of excessive carbon monoxide.

⚠ WARNING

SCALD HAZARD: Never allow infants or children to adjust the water temperature or be left unsupervised when using hot water. Tankless water heaters adjust quickly and may lead to serious injury if not properly used.

⚠ WARNING

Never store gasoline or other fuel sources near this appliance.

⚠ WARNING

The hot water heater must be operated in the manner intended and with the instruction provided by the manufacturer. Failure to follow these instructions may lead to serious injury, fire, or explosion, property damage or death.

⚠ WARNING

BURN OR SCALD HAZARD:

- NEVER drain the hot water heater while hot.
- NEVER perform work on the water heater while it is operating.
- NEVER perform work unless the Electrical and LP gas supply is shut off.
- NEVER perform work while the appliance is hot.
- NEVER actuate the pressure relief valve if the appliance is still hot.

J. BATHROOM SHOWER

1. General

Unlike a household, the RV does not contain a water pressure balance valve. Refrain from running other water sources while the shower is in use. Air may need to be purged from the lines before a steady stream can flow.

- Always be aware of the holding tank capacities. Water that is used will drain directly into the gray holding tank and can back up when full.
- Turn the water heater **ON** and allow the coils to heat.
- If dry camping, the water pump will need to be turned **ON**.
- Adjust the hot and cold temperatures with the faucet knob. Make sure the desired temperature is achieved **BEFORE** entering the shower.
- To conserve water, wet down and turn **OFF** the water supply while washing. Then, turn **ON** to rinse.
- When finished, shut **OFF** the knobs to the hot and cold water.

+ NOTICE

There is no shut-off valve at the shower head. Water must be shut OFF using the knobs on the faucet. Once water is shut OFF, water may slightly drip from the shower head. This is normal and is NOT an indication of a leak.

2. Maintenance

The shower walls within the RV are made of fiberglass and should be cleaned with a mild dish soap and water solution only. **DO NOT** use abrasive or harsh chemicals, compounds, or soaps when cleaning the shower.

SEC.20 PLUMBING SYSTEMS

3. Shower Door

Your RV is equipped with a glass shower door. The door has three (3) individual panes of glass that make up the door. These 3 panes of glass slide side to side in the shower door extrusions to permit ingress and egress into the shower. It is important to ensure that the travel latch on the shower door is properly latched prior to travel. Depending on the bathroom layout, the latch could be located on the interior or exterior of the door. In the picture provided below, the travel latch is located on the interior of the shower door.



⚠ CAUTION

It is very important that you properly stow the shower door for travel as indicated by the above provided instructions. Failure to latch the shower door in its travel position will likely lead to the shower door glass shattering in transit. This is a common occurrence as people tend to forget this step before towing the RV. A shower door with shattered glass is not covered by either the Brinkley RV or the shower door manufacturer's warranties.

OPERATING THE SHOWER LATCH:

1. To open, rotate the latch upward to release the door from its travel latched position.



2. To close, rotate the latch down until it is fully seated around the knob. You should feel it snap into place when it is properly seated.

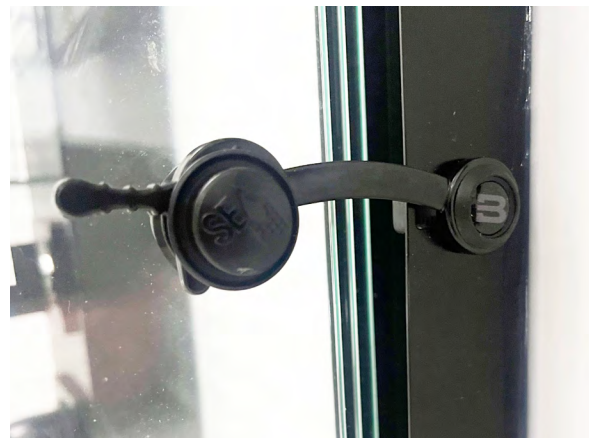

K. FAUCETS

The faucets installed within the RV operate much like those in your home.

- Make sure there is a sufficient water supply.
- Turn ON the water pump if dry camping.
- Turn ON the water supply at the faucet and adjust temperature.
- Turn off when finished.

L. EXTERIOR SPRAY PORTS

There are two (2) exterior sprays parts on your Brinkley RV.

The first spray port is located on the convenience center found within the pass-through storage compartment on the off door (driver) side of the RV. The below photo shows the convenience center and the location of this spray port.



The second spray port is located on the wall of the pass-through storage on the door (passenger) side of the RV. The photos below show the spray port and its location.



OPERATING THE SPRAY PORTS:

1. **ATTACH** the supplied quick-connect hose and sprayer to the spray port found at the convenience center.
2. **Ensure** the tankless hot water heater is turned **ON** if you desire hot water at the external spray ports.
3. **When** dry camping, turn **ON** the water pump.
4. **Turn ON** the hot and cold water using the knobs and adjust the temperature accordingly.

WHEN FINISHED:

1. **Turn OFF** the hot and cold water using the knobs.
2. **DISCONNECT** the quick-connect sprayer and allow excess water to drain.

SEC.20 PLUMBING SYSTEMS

M. NAUTILUS P4-3 CONVENIENCE CENTER

1. General

Your Brinkley RV is equipped with a Universal Docking Convenience Center (referred to as “convenience center” throughout this manual). It is called the Nautilus P4-3 Handle system. The instructions on how to utilize the convenience center is covered in detail in the paragraphs that follow.

+ NOTICE

IMPORTANT – NEVER push the check valve on the “CITY WATER” connection with pressure in line. This will cause irreparable damage to the check valve function. See the picture below for location of the check valve on the city water connection.

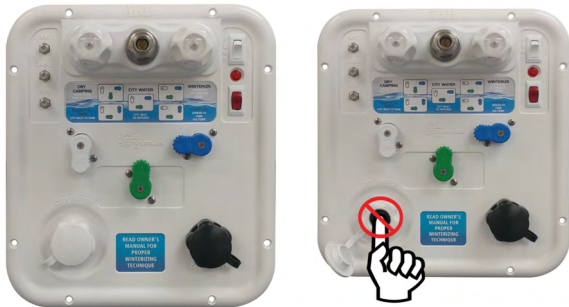

THE NAUTILUS P4 PANEL SYSTEM WILL ALLOW YOU TO PERFORM THE FOLLOWING FUNCTIONS:

1. Power fill your fresh water tank for remote or dry camping.
2. Use your water pump to supply water to fixtures from the freshwater tank.
3. Use your water pump to siphon fill or sanitize your freshwater tank from a bucket.
4. Connect to city water at the camping site to supply water to the fixtures.
5. Winterize your plumbing lines and fixtures.
6. Rinse the black tank to help control odors and prevent sewage buildup.
7. Rinse off items outside the unit with a hot or cold faucet.
8. Connect coax lines with satellite, cable, and auxiliary.

2. Handle Position and Valve Routing

WHITE HANDLE

Receives water from water inlet on front of panel.

Sideways—water goes to pump inlet.

Down—water goes into blue handle.

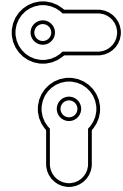

BLUE HANDLE:

Receives water from the white handle valve/water inlet on front of panel.

Sideways—water goes to fixtures (cold).

Down—water will go to or come from fresh water tank.

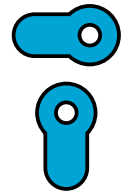

GREEN HANDLE:

Is an on/off through valve that feeds pump from fresh water tank.

Sideways—water will not flow through valve.

Up—water will go to or come from fresh water tank.

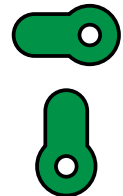

For full operation, maintenance, and troubleshooting instructions for the Nautilus P4-3 Handle Convenience Center, click on the link or scan the QR Code below.



[Nautilus P4-3 Handle Owner's Manual](#)

N. DRAINING THE FRESH WATER SYSTEM

Before storing the RV throughout winter months, the water system should be drained and winterized. This should be completed for all components of the water system including the hot and cold-water lines, water heater, faucets, and P-traps. Under your RV, you will notice red and blue water lines with shut OFF valves. These release the water within the supply lines and are referred to as the low point drains.

DRAINING THE FRESH WATER SYSTEM:

1. **OPEN** all faucets, including the outside shower (If Equipped) and external spray down ports.
2. **OPEN** the Fresh Water Holding Gate Valve. This valve is a white T-handle valve that is located under the RV and close to the axle.



3. **OPEN** all low point drains. See photo below.



4. **DRAIN** all sinks.
5. **Turn ON** the water pump to ensure all water is purged from the RV.
6. **After** draining the Fresh Water System, **REVERSE** these steps to ensure the system is closed back up. It is common for a small amount of water to remain in the system.

O. SANITIZING THE FRESH WATER SYSTEM

The Fresh Water System should be sanitized after purchase of the RV, anytime contamination may have occurred, and after extended periods of no use. Please follow the below instructions to sanitize the Fresh Water System.

- Mix one (1) gallon water (3.78 liters) with a ¼ cup (59.14 ml) of household bleach (5% sodium hypochlorite solution).
- You will need approximately one (1) gallon (3.78 liters) of solution for every fifteen (15) gallons (56.78 liters) of tank capacity.

SANITIZING THE FRESHWATER SYSTEM:

1. **ENSURE** the RV is level.
2. **EMPTY** the fresh tank by opening the fresh water holding gate valve.
3. **CLOSE** the fresh water holding gate valve.
4. **ENSURE** the low point drains are closed.
5. **CONNECT** a garden hose to the City Water port and the other end into the sanitizing solution. **DO NOT** use your portable freshwater hose.
6. **Turn ON** the water pump and run it until the solution is empty.
7. **PROCEED** by filling the freshwater holding tank.
8. **PURGE** all waterlines by turning on the faucets. You must purge both the hot and cold lines of each faucet. Once completed, turn **OFF** the water pump.
9. **ALLOW** the sanitizing solution to stand for at least three (3) hours.
10. **DRAIN** and **FLUSH** the Fresh Water System with fresh water.
11. **To** remove excess chlorine odor, mix one (1) quart (.94 liters) vinegar to five (5) gallons (18.9 liters) water and repeat steps 3-9 above.

SEC.20 PLUMBING SYSTEMS

P. WINTERIZING THE PLUMBING SYSTEM

Preparing for storage is vital step for the protection of your RV. Anytime temperatures are likely to drop near or below 32° F (0° C), the RV should be winterized. This is to prevent the waterlines, tanks, and the water heater from freezing and becoming damaged. The plumbing system should only be winterized with RV antifreeze and no other solutions.

+ NOTICE

Always clean RV antifreeze from all surfaces to prevent staining in the sinks, tub, or toilet.

⚠ WARNING

NEVER use automotive antifreeze or windshield washer anti-freeze as they are poisonous. They are harmful when consumed and may be fatal if swallowed.

+ NOTICE

Winterizing the RV may be more efficient and easier if another person is able to assist you. Please contact your Dealer for assistance if needed.

BEFORE YOU START:

Here are the items that you will need:

1. (3) gallons (11.35 liters) of non-toxic RV/Marine antifreeze (Customer Supplied).
2. Air compressor with pressure regulator capable of producing a maximum of 30 PSI (206.8 kPa) of pressure.
3. Standard Air Compressor Quick Connect Fitting. Picture shown above right (Customer Supplied).



STANDARD AIR COMPRESSOR QUICK-CONNECT 1/4" INTERCHANGE

STANDARD MALE GARDEN HOSE FITTING

4. A short length of garden hose that has a male fitting on one end.
5. A full-length garden hose or the supplied retractable hose reel to flush the black and gray tanks.

+ NOTICE

The black and gray tanks should already be emptied of wastewater before commencing the winterization process.

FOLLOW THESE STEPS TO WINTERIZE:

1. **LEVEL** the RV. See [Section 8](#).
2. **CONNECT** the provided hose from the retractable hose reel or a full-length garden hose to the tank flush inlet and to a water supply source (i.e., an outside water spigot). See picture below for the hose attachment location.



3. **FLUSH** the black holding tank(s) utilizing the tank flush line.
4. **DRAIN** all black, gray, and freshwater holding tanks.
5. **CLOSE** the black, gray, and freshwater valves after they have all drained.
6. **SET** the convenience center panel to **POWERFILL** by setting the valves on the convenience center as indicated in the picture below. The blue and white valves should be pointed downward. The green valve should point left.



8. **Turn OFF** the water pump. You can turn the water pump off at the Convenience Center (picture below left).



7. **Turn OFF** the water heater from the water heater controller in the bathroom cabinet. Use compressed air to blow out the remaining water in the water heater. This can be performed by opening the low point drains, all hot handles on the faucets, and connecting air to the water inlet. Make sure you do not exceed 30 psi (206.8 kPa) when blowing compressed air into the waterlines. The picture above right shows the location of the water heater on the exterior of the unit on the off door side.

9. **OPEN** the low point drains. They are located underneath the RV on the off door side of the RV and protrude through the underbelly. Allow all water to drain.



NOTE: Reference the [RVMP flexTemp™ On-Demand Tankless Water Heater Owner's manual](#) (click the link or scan the QR Code with your smart device).

10. **FLUSH** the toilet to remove all water from the toilet bowl. You will need to keep the toilet flush foot pedal depressed on the toilet until all water is drained from the toilet.

SEC.20 PLUMBING SYSTEMS

11. **OPEN** all interior faucets and turn **ON** the interior shower(s). You should complete these steps at each faucet one at a time. At each location:

- Start by opening the hot water valve. Leave the valve open until all water is drained. Then close the hot water valve.
- Then, open the cold-water valve. Leave the valve open until all water is drained. Then close the cold-water valve.
- **NOTE:** If the faucet does not have separate hot and cold-water valves, you must first open the valve with the handle set all the way to hot. Then move the handle all the way to cold.

12. **CONNECT** using the supplied quick connect hose (see picture in 'c' below) to the exterior faucets (one at a time).

- Start by opening the hot water valve. Leave the valve open until all water is drained. Then close the hot water valve.
- Then, open the cold-water valve. Leave the valve open until all water is drained. Then close the cold-water valve.
- Repeat at the other exterior faucet location. The two locations are shown in the photos immediately below:



13. **SET** the Convenience Center Panel valves as indicated in the picture at the top right:



14. Using the **CITY WATER INLET** (located at the red circle shown in the picture above) on the convenience center panel:

- **ATTACH** the air compressor quick connect fitting to the city water inlet.
- **ATTACH** the air compressor hose to the quick connect fitting.
- **SET** the air compressor regulator to 30-40 psi (206.8-275.8 kPa).
- **TURN** the air compressor on.

15. **CLOSE** the low point drains after allowing all water to drain.

16. **REPEAT** steps 10, 11 and 12 above while the air compressor is still attached and on.

17. **TURN OFF** the air compressor and disconnect the air hose and fitting from the **CITY WATER** inlet on the convenience center.

18. **SET** the valve handles on the convenience center panel to **WINTERIZE** as shown in the photo below:



19. **CONNECT** a short section of garden hose to the inlet labeled “**CITY WATER**” on the convenience center panel and as shown in the picture immediately above.
20. **PLACE** the other end of the garden hose into the RV antifreeze jug.
21. **TURN ON** the water pump. See step 8 for the water pump switch locations.
22. **The pump** should be running, and the RV antifreeze should begin to flow through the pump into the plumbing lines and fixtures.
23. **REPEAT** steps 10, 11 and 12 until antifreeze is present at each location. You should permit RV antifreeze to flow from each fixture. You must perform this at each location one at a time.
24. **TURN OFF** the water pump once antifreeze is present at all fixtures.
25. **DISCONNECT** the garden hose from the convenience center panel.
26. **POUR** RV 1/2 cup (118.3 ml) of RV antifreeze down each sink drain and 1 cup (236.6 ml) of RV antifreeze down toilet drain.
27. **COMPLETE!** Your plumbing system is now prepped for winter storage.

Q. DE-WINTERIZING THE PLUMBING SYSTEM BEFORE YOU START:

You will need the following items before you start the de-winterization process:

- A 5-gallon (18.9 liters) bucket.
- Household bleach.
- 8-12 ounces (236.6-354.8 ml) of fresh water in a small bottle.
- A liquid measuring cup.
- A garden hose (or utilize the supplied hose of the retractable hose reel).

The Fresh Water System should be sanitized after purchase of the RV, anytime contamination may have occurred, and after winterization or extended periods of no use. Please follow the below instructions to sanitize the freshwater system:

- Mix one (1) gallon (3.78 liters) water with a ¼ cup (59.14 ml) of household bleach (5% sodium hypochlorite solution).
- You will need approximately one (1) gallon (3.78 liters) of solution for every fifteen (15) gallons (56.78 liters) of freshwater holding tank capacity. You should place this mixture in the 5-gallon (18.9 liters) bucket.

Please consult your Dealer if you have questions regarding the size of your fresh water holding tank or contact Brinkley RV Customer Care.

To De-Winterize, follow the following steps:

1. **ENSURE** the RV is level (See [Section 8](#)).
2. **ENSURE** the low point drains are closed. They are located underneath the RV on the off door side of the RV and protrude through the underbelly. See the picture below for an example of the low point drains.



3. **CONNECT** the provided hose of the integrated hose reel or a garden hose to the CITY WATER port on the convenience center. See picture, right. Place the other end of the garden hose in the 5-gallon (18.9 liters) bucket that contains your sanitizing solution.

SEC.20 PLUMBING SYSTEMS

4. **SET** the convenience center valves to SIPHON (white valve pointing right, blue valve pointing down, green valve pointing left). See picture, below.



5. **TURN ON** the water pump and fill the fresh tank with the full amount of sanitizing solution. You can turn the water pump on at the Convenience Center (picture below left).



6. **FLUSH** the toilet and keep the foot pedal depressed on the toilet until all the RV antifreeze is purged from the toilet and the sanitizing solution is flowing into the toilet bowl.
7. **ADD** 8-12 ounces (236.6-354.8 ml) of fresh water into the toilet bowl to dilute the sanitizing solution at the toilet seal.
8. **OPEN** all interior faucets and turn **ON** the interior shower(s). You should complete these steps at each faucet one at a time. At each location:

- Start by opening the hot water valve. Leave the valve open until all the RV antifreeze is purged and the sanitizing solution is present and flowing from the faucet. Then close the hot water valve.
- Then, open the cold-water valve. Leave the valve open until all the RV antifreeze is purged and the sanitizing solution is present and flowing from the faucet. Then close the cold-water valve.

+ NOTICE

If the faucet does not have separate hot and cold-water valves, you must first open the valve with the handle set all the way to hot. Then, move the handle all the way to cold.

9. **CONNECT** using the supplied quick connect hose to the exterior faucets (one at a time).
 - Start by opening the hot water valve. Leave the valve open until all the RV antifreeze is purged and the sanitizing solution is present and flowing from the faucet. Then close the hot water valve.
 - Then, open the cold-water valve. Leave the valve open until all the RV antifreeze is purged and the sanitizing solution is present and flowing from the faucet. Then close the cold-water valve.
 - Repeat at the other exterior faucet location.
10. **ALLOW** the sanitation solution to stand in the water lines for at least three (3) hours.
11. **DRAIN** all black, gray, and freshwater holding tanks.

12. **FILL** the freshwater holding tank with fresh water only. Repeat step 7 through 11 above to purge the system of the sanitizing solution. Note that each fixture should be run for approximately 20 seconds each to flush the lines of the sanitizing solution.
13. **REPEAT** step 12 in its entirety a second time to ensure the sanitizing solution is completely removed from the plumbing system.
14. **COMPLETE!** You are now ready to go RV'ing!

R. BLACK WATER AND GRAY WATER SYSTEMS

The toilet in the RV drains to the black water holding tank. The shower and sinks within the RV drain to the gray water holding tank.

- Before towing the RV, the gray and black holding tanks should be emptied to avoid carrying unnecessary weight.

If you are unable to empty the tanks while dry camping, reduce your towing speed until these tanks can be emptied at the next dump station.

+ NOTICE

The cargo carrying capacity of the RV is based on ALL holding tanks being empty. If the tanks are full, this weight must be deducted from the cargo carrying capacity unless in Canada.

⚠ WARNING

Traveling with full holding tank(s) may result in:

- Limiting available cargo carrying capacity
- Exceeding the GAWR or GVWR
- Damage to suspension components (i.e., as springs, tires, and axles).
- Fluctuating hitch weight, depending on the location of the holding tanks and which tanks are filled.
- Unwanted towing characteristics such as trailer sway and other handling difficulty.

S. TOILET

1. General

The toilet in the RV uses roughly three (3) quarts (2.84 liters) of water per flush. This amount is about ten times less than that of a residential toilet. When flushing solids, additional water may be needed to fully remove waste from the lines.

+ NOTICE

When flushing, ALWAYS continue to run water for an extra 10-15 seconds after flushing.

If enough water is not used, pipes and tanks may become clogged.

⚠ WARNING

NEVER use automotive antifreeze, windshield washer anti-freeze, laundry detergents, or other caustic chemicals as they are poisonous. Although these products may have deodorizing capabilities, they are damaging to the components within the plumbing system and are toxic if ingested.

2. Preventing Toilet Blockage

- Before using the toilet, ensure there is sufficient water in the toilet, approximately 4-6 inches (10.16-15.24 cm). This can be accomplished by flushing the toilet several times until water is present.
- Use RV grade, single-ply toilet paper.
- Never flush baby wipes, disposable wipes, or any other foreign objects down the RV toilet (i.e., hygiene products, feminine products, cleaning wipes, paper towels, diapers).

3. Cleaning and Maintenance

- Clean the toilet on a regular basis.
- Use tank treatments to clean the black tank when needed.
- Apply petroleum jelly when needed to the toilet ball valve to provide waterproof lubrication without damaging other seals.

SEC.20 PLUMBING SYSTEMS

+ NOTICE

Never use chlorine or other abrasive solutions in the RV toilet (i.e., laundry bleach, chemical drain openers). These products will **DAMAGE** the seals in the toilet and dump valves.

+ NOTICE

It is vital to prevent solid buildup in the drain lines and black tank. Follow the toilet manufacturer's manual for instructions and maintenance information.

T. BLACK AND GRAY WATER HOLDING TANKS

1. Black Water Tank Preparation

To help break down solid contents within the tank and to minimize odors, a deodorizer treatment (Customer Supplied) should be used. Please see the following instructions.

AFTER DUMPING THE HOLDING TANKS, AND BEFORE THE FIRST USE:

1. **RELEASE** roughly one to two quarts (1-2 liters) of water into the toilet bowl.
2. **ADD** the suggested amount of tank deodorizer (Customer Supplied) by inserting the content into the toilet.
3. **FLUSH** the toilet and allow an additional two (2) gallons (7.57 liters) of water flow into the holding tank.

2. Gray Water Tank Preparation

No preparation is needed for the gray tanks. To help control odors, add a small amount of baking soda or RV tank deodorizer down the drains as needed.

3. Emptying Black and Gray Water Tanks

At the top of the convenient center, you will find the black and gray tank drain valve switches, also referred to as dump valve switches. When dumping the black and gray tanks, it is important to dump the black holding tank first, then the gray tank. This will help to remove any solids left behind from dumping the black tank.

EMPTYING BLACK AND GRAY TANKS:

1. **Generally**, accumulated solid waste will loosen within the black holding tanks as the RV is transported to a disposal location.
2. **Always** level the RV before dumping to make the process more efficient. See [Section 8](#).
3. **LOCATE** the Sewer Outlet on the off door side.
 - **REMOVE** the housing cap on the outlet.
 - **ATTACH** a sewer hose to the outlet (Customer Supplied).
4. **PLACE** the opposing end of the sewer hose in the designated dump location.
5. **OPEN** the Black Tank Dump Valve by pressing the black dump switch to the **OPEN** position. The indication light will then turn on signifying the dump valve is open.
6. **CLOSE** the tank valve by pressing the dump valve switch to the **CLOSED** position. The indication light on the black dump valve switch will turn off signifying the dump valve is closed.
7. **EMPTY** the gray tanks by pressing the gray dump valve switch to the **OPEN** position. The indication light will then turn on signifying the dump valve is open.
8. **REMOVE** the sewer hose once all tanks are emptied, clean them, and store for the next use.
9. **ENSURE** the cap on the sewer outlet is reinstalled.

When Connected at the Campground Sewer

Drain: Keep the dump valve switches closed until the tanks are ¾ full to prevent solids from building in the drain lines. Never keep the black dump valve switch open.

4. Gray and Black Tank Valve Switches, Sewer Outlet, and Sewer Hose Storage Tube

The picture below shows the black and gray tank valve switches. They are located at the top of the convenience center panel.



The picture below shows the sewer outlet on the off door (driver) side of the RV. The sewer outlet cap on your RV is clear so that you can make sure there is not wastewater behind the cap prior to taking the cap off.



The picture below shows the sewer hose storage tube. The tube is capable of storing two sections of hose. The valve ends of the hose have to be removed prior to storage.

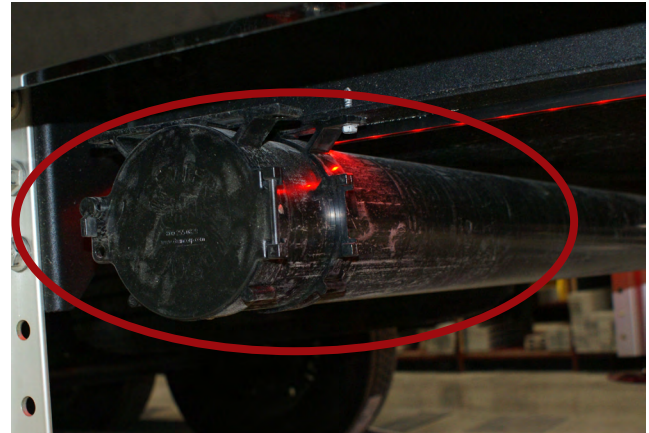

5. Manually overriding the Gray and Black Power Tank Valves

In the event that you lose power to your RV or the electric tank valves are not functioning, you can utilize the manual override to open and close the tank valves.

You have three override valves within your RV. Two are located centered behind the front pass-through storage just under the underbelly of the RV, and the other is located towards the off door (driver) side of the RV just behind the rear axle, under the underbelly. The photo below shows the general areas of the overrides circled in red.



SEC.20 PLUMBING SYSTEMS

TO MANUALLY OVERRIDE THE FRONT TANK VALVES:

- Locate and open the compartment door on the off door (driver) side right of the pass-through compartment.



- Open the underbelly access door to reveal the tanks and the plumbing components.
- Locate the motorized drain valve assembly (shown below). Pull out the motorized valve pin from the horizontal actuator support arm. Grasping the support arm, the valve may be pulled open or pushed closed manually.
- Reverse these steps to reassemble your RV once the valve is back into its closed position and the pin is reinserted.

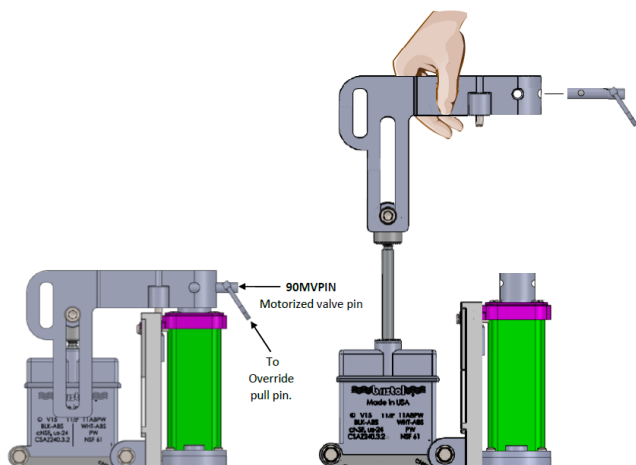

TO MANUALLY OVERRIDE THE REAR TANK VALVES:

- Locate and open the underbelly access door found just behind the rear axle. This will reveal the rear tank and its plumbing components.
- Locate the motorized drain valve assembly (shown below). Pull out the motorized valve pin from the horizontal actuator support arm. Grasping the support arm, the valve may be pulled open or pushed closed manually.

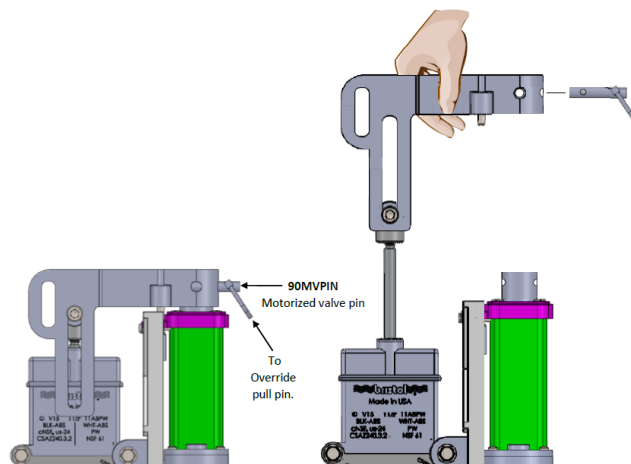

- Reverse steps 1 and 2 to reassemble your RV once the valve is back into its closed position and the pin is reinserted.

For further assistance, please contact your Dealer or Brinkley RV Customer Care.

6. Dump Station Locations

Dump station can be found on many websites, campground ground offices, and publications including Good Sam Camp Guide, KOA campgrounds Camp Guide, Woodall's Campground Magazine, Rand McNally Camp Guide, etc. Dump stations can also sometimes be found at local gas stations.

The sewer hose and its components are the Customers responsibility to purchase. If you happen to need assistance, please contact your Dealer.

7. Vents and Vent Pipes

It is vital to keep all exterior plumbing vents clear and free of any possible obstructions. If these vents become clogged or obstructed, the tanks will not be able to properly drain. Inspect these vents on a continuous basis and clean as needed.

8. Drainpipes With Dry Sealing Valve

A dry, waterless P-trap is used on the drain system of the RV. This form of P-trap will help to prevent odors from escaping the waste system and will eliminate the need of a traditional P-trap. In the circumstance the drain becomes clogged with this installation, a mechanical clean-out tool will need to be used to clear the obstruction.

+ NOTICE

The dry waterless P-trap **MUST** be removed before using a mechanical clean-out tool. If the dry valve is not removed, the seal will become damaged and will not operate as designed. This will become evident as you will begin to smell odors from the drainage.

9. Black Tank Flusher

Your RV is equipped with a black tank flusher. This feature is designed to rinse the interior portion of the black tank through a separate water connection port. To prevent water from back flowing, there is a check valve installed in-line. See Section 20M(7), Rinsing the Waste Tank—"Tank Flush."

FLUSHING THE TANK AFTER DUMPING:

1. After draining the tanks, leave the sewer hose connected to the drain outlet and the dump location.
2. Connect the external water source to the black tank flusher inlet.



3. Open the black tank valve.
4. Turn on the water source to flush the tank.
5. When the drainage begins to run clear from the sewer hose, turn off the water source and disconnect it from the RV.
6. Disconnect the sewer hose **AFTER** all water is drained from the system

⚠ WARNING

When the tank is being flushed, the black tank gate valve must be open. Failure to open the valve will result in damage to the system and may lead to unsanitary conditions that may further result in illness or personal injury.

+ NOTICE

DO NOT add any check valves to this system or leave any hose connected when not in use.

SEC.21 FURNITURE

A. ENTERTAINMENT RECLINER SOFA

The sofa found within the main living quarters of the RV is an entertainment recliner sofa. Each section of the sofa is capable of being reclined via the pull handles displayed in the below photo.



To engage the recline position, simply pull the handle in an upward position until you feel the foot rest release.

At each end of the sofa, you will notice a round control recessed in the arms of the sofa. This control contains a USB-A charge port along with controls for the heat and massage features of the sofa. To turn the heat feature on, press the button with the red heat waves. When the button is illuminated, the heat feature is on. Depending on the temperature of the RV, it may take a couple minutes for the seat to warm.

To operate the massaging feature, press the button with the blue massage icon. The button will illuminate when the massage feature is activated. Upon engaging the massager, you will immediately feel the vibration in the back rest of the sofa.

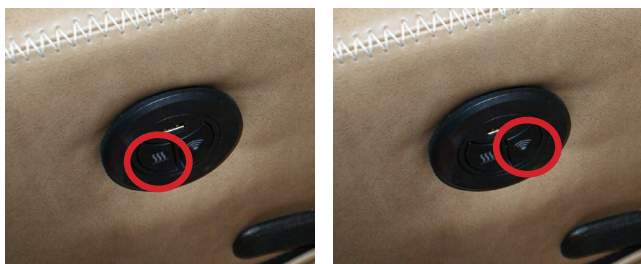

B. BEDROOM DRESSER

The dresser located in the main bedroom also has hidden storage located underneath the dresser top. To access the storage, simply pull the dresser top forward, as it is attached to a set of drawer glides. The picture below shows the dresser top in the closed position.



The following picture shows the dresser top in the open position providing access to the upper storage area of the dresser.



C. HAPPIJAC SOFA

Under the Happijac bunk in the garage there are two Happijac sofas. These particular sofas can be used either as sofas or as an additional bunk bed.



HAPPIJAC SOFA TO BED:

1. Pull the top of the back rest towards the center of the garage.
2. Pivot the back rest of the sofa forward and then fully rotate the back rest until it is in the bunk position.



3. Locate the support legs under the sofa backrest. Rotate the legs 90 degrees and extend them until they make contact with the garage floor. Prior to applying weight to the bed, make sure the detention lock circled in red is fully engaged.



For additional information on the Happijac system, please See [Section 10](#).

SEC. 22 ENTRY DOOR & STEP SYSTEM

Your RV has two primary entry points: the main entry door in the main living area, and the secondary entry door in the garage area. Each door contains its own unique purpose and features which are outlined and explained below.



[Lippert Entry Doors and Accessories Product Support](#)

A. MAIN ENTRY DOOR

1. Integrated Window Shade

The picture below has a red rectangle around the entry door window. This is the location of the pleated integrated window shade. To operate, you must be outside the unit and separate the screen door from the main entry door. This will give you access to the shade. Simply pull up or down on the shade to extend or retract the shade.

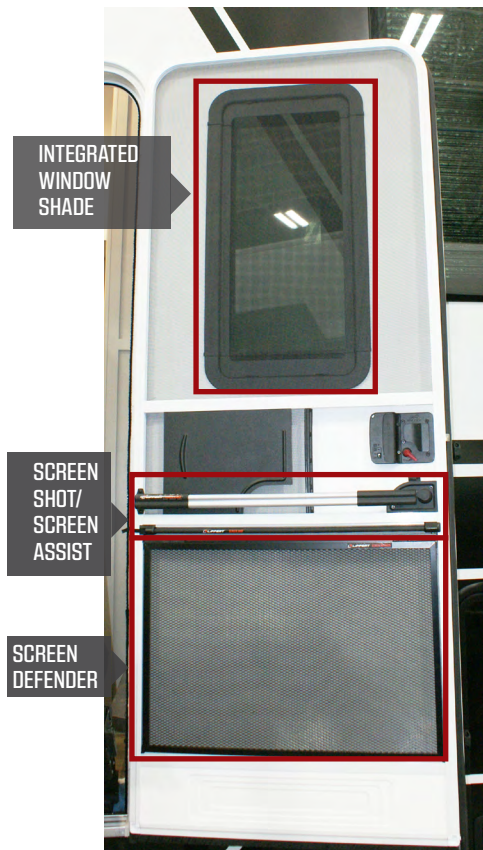

2. Lippert Screen Shot

The middle red rectangle highlights two features of the entry door. The first is the Lippert Screen Shot. This is the black tube that runs parallel to the ground below the door latch. It has a spring-loaded strap that automatically shuts the screen door after it has been opened.

3. Lippert Screen Assist

The second feature indicated by the middle red rectangle in the picture to the right is the Lippert Screen Assist. This item is connected to the screen door latch and allows you to press down on the Lippert Screen Assist to open the screen door.

4. Lippert Screen Defender

The last feature on the interior of the entry door is the Lippert Screen Defender. This item is a removable screen that protects the lower portion from the screen door against pets and small children damaging the screen or pushing through the screen to the exterior of the unit.

5. Keyless Entry

Your entry door comes equipped with a 5-touch button, programmable deadbolt lock, that utilizes a 4-digit code. This will allow keyless entry into the RV. Four of the buttons are labeled “1/2”, “3/4”, “5/6”, and “7/8”. The fifth button is the lock/unlock button that tells the lock to lock or unlock after the pass code is entered.



[RV Lock Keyless Entry Product Support](#)



USING THE ENTRY DOOR KEYPAD:

1. Touch any number to “Wake Up” the lock.
2. You will notice the buttons light up when the lock is “awake”.
3. The default code is 1, 2, 3, 4 followed by the unlock or lock buttons. Refer to the [manufacturer's manual](#) for the programming instructions

+ NOTICE

The keyless touch pad only locks and unlocks the entry door deadbolt. The paddle or handle lock is keyed. If you intend to lock the RV without taking your keys, make sure the paddle lock is unlocked and only the deadbolt is locked.

⚠ CAUTION

Do not powerwash the keyless entry door lock or use abrasive cleaners on the lock and keypad. Doing so can permanently damage the lock and keyless entry feature.

6. Telescoping Handrail

Your RV is equipped with a telescoping handrail to facilitate safe ingress and egress into and out of the RV. The picture below shows the location of the handrail. It is held in place for transit utilizing a magnet and travel pin.

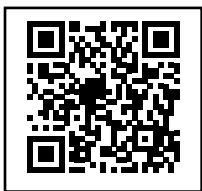

[MORryde Safe-T-Rail](#)
[Product Support](#)

DEPLOYING THE HANDRAIL:

1. Remove the travel pin and grab the handrail at the bottom. Pull outward as shown in the picture below.



2. There is an inner and outer channel that comprises the handrail. Once the handrail is extended in step (1), firmly grab the inner channel located at the bottom of the handrail and pull it down and outward until the inner channel is fully extended. When complete, your handrail should look like the photo below.



3. Reverse steps (2) and (1) above to stow the handrail for travel. Be sure to fully seat the handrail so that the magnet engages to the side wall of the RV and insert the travel pin.

7. Main Entry Door Step System

Your main entry door step stows inside of the entry door.

DEPLOYING THE MAIN STEPS:

1. Open the entry door fully.



2. While holding on to the step, pull the blue lever to release the step from the door jamb. See the picture below displaying the blue handled latch.



⚠ WARNING

It is important that you have a good grasp on the step as you are lowering the step system. A failure to hold on to the step firmly could result in the step system dropping suddenly and hitting you on the head, neck, shoulder, or face resulting in injury.



[MORryde Flip Tread Step](#)
[Product Support](#)

3. Slowly walk backwards and allow the step to lower to the ground.
4. Grab the top of one of the step treads and pull towards you until the steps are fully seated in the down position. The steps should look like as shown in the picture below.



5. Adjust the extension legs of the step on both sides by pulling the provided pins and adjusting the leg lengths so that the step treads are parallel to the ground. Please see the picture below for the location of the adjustment pins.



6. Reverse the steps to stow your step system for travel. Note that the steps can be cleaned and allow any water to run off prior to stowing the step by flipping the treads into the up position. Clean as needed.

⚠ WARNING

When putting the step away for travel, it is important that you ensure the blue latching mechanism is properly latched to the entry door jamb. Failing to do so could result in the step system detaching from the door jamb in transit resulting in damage to the step, entry door, and potentially other interior components of the RV.

⚠ WARNING

Make sure you hold onto the steps the entire time while lowering and lifting them into position. If you feel you are unable to handle the weight of the stairs, ask for help prior to attempting to operate on your own. Failure to do so may result in personal injury or harm.

B. GARAGE ENTRY DOOR

The garage entry door contains many similar features as the main living entry door but does vary slightly. The features are outlined above right.



1. Lippert Screen Shot
2. Lippert Screen Assist
3. Lippert Screen Defender
4. Keyed Lock

- Your garage entry door comes equipped with a keyed deadbolt lock. The keys will be supplied with your RV at the time of purchase.

5. Grab Handle

- The garage entry door comes equipped with a grab handle. This grab handle is directly attached to the sidewall of the RV.

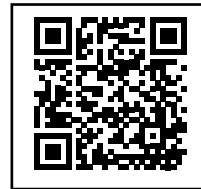

[Lippert Entry Doors and Accessories Product Support](#)

6. Garage Entry Door Steps

The garage entry door is equipped with the same style steps that are on the main entry door. Refer to that section for the instructions.

C. COMPARTMENT AND ENTRY DOOR KEYS

All entry doors and main compartment doors on the RV utilize the Keyed Alike system. One key will open any lock on the RV with the exception of the dead bolt found on the main entry and the garage entry doors. The deadbolt on the main entry door and the garage entry door have a separate key that can operate both locks.

If additional keys are needed, please contact your Dealer or Brinkley Customer Care.

SEC.23 RAMP DOOR & PATIO

Your Brinkley RV is equipped with a MORryde ZERO-G ramp door system and patio assembly. The MORryde ZERO-G ramp door system is a gravity resistant, hinge-less assembly that is specially designed to be hassle-free when operating.

+ NOTICE

Your MORryde ZERO-G patio door is rated for 3000lbs when in “ramp mode” and 1500 lbs. in “patio mode.” Both ratings are calculated assuming an even weight distribution across the ramp door. These weights are static weights and are to never be exceeded.

The ramp door is also equipped with an anti-slip interior surface to aid loading and unloading vehicles from the garage area.



[MORryde Zero-G Ramp Door Product Support](#)

A. RAMP DOOR OPERATION

The ramp door can be opened from outside or inside the RV. The ramp door can be opened and rotated parallel to the ground, so it can be used as the patio floor. This position is known as the “patio position.” The ramp door can also be lowered all the way to the ground and used as a ramp. This position is known as the “ramp position.”

1. Exterior Operation

To unlock your ZERO-G ramp door from outside the unit, you will need to insert the provided key into the ramp door release lock located on the lower right side of the ramp door jamb. Once the key is inserted, rotate the key counter clockwise. This motion will disengage the electronic latching system at the top of the door. Once you hear the locking mechanism release, this means the electronic actuators have opened, and the door will begin to open from its previously closed

position. **OUTSIDE RAMP DOOR OPERATION:**

1. Locate the provided ramp key and ramp door release lock. The photo below will show the location of the key insert relative to the ramp door. The ramp door release lock is covered by a black rubber protective cap. This cap must be removed to expose the lock.



2. With one hand on the ramp door, insert the key and rotate counter-clockwise to release, or unlock, the ramp door.



3. Guide the ramp door down to the desired position. If the support cables are connected to the ramp door, the door will only open to the patio mode position. To allow the door to fully rotate down to the ground, you must first disconnect the support cables from the ramp door on each side. Both positions are shown below.

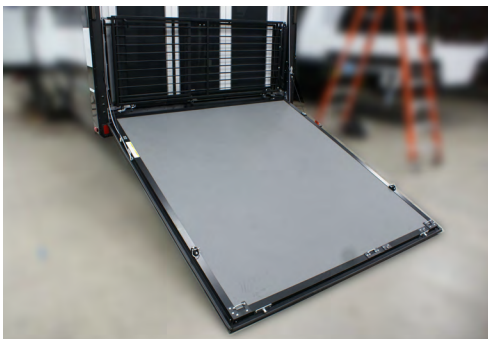
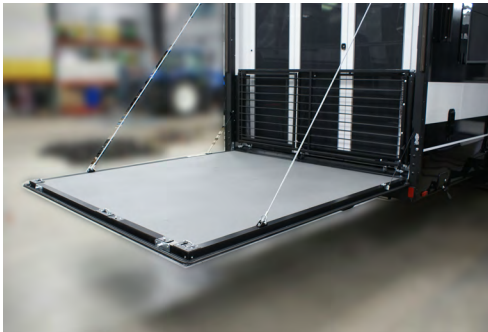

4. To close the ramp door, ensure the garage entry door is open. This will allow air to escape the garage as the ramp door closes.
5. Lift the ramp door back up into the closed position.
6. Forcefully push the ramp door firmly against the RV until a latching sound is heard.
7. Verify the door latched by pulling hard on the grab handle of the ramp door. If the door moves, reopen the door and repeat steps 4 through 6 until the ramp door securely closed.

⚠ WARNING

The ramp door may start to fall open once the ramp door release lock is released with the supplied key. Be prepared to brace the door and gently guide the door to its desired position to avoid potentially damaging the door framing. Failure to do so may result in damage to the RV, personal injury, or death.

+ NOTICE

To operate the ZERO-G ramp door system from outside the unit with the provided key, the unit must have power to operate the electronic actuators inside the ramp door jamb.

⚠ WARNING

The garage entry door must be open for the ramp door to be properly closed. If this door is not opened, too much pressure will build in the garage area and in return, the ramp door will not securely close. As a result, damage to your RV, to other vehicles, personal injury, or death may occur.

2. Interior Ramp Door Operation

If no power is available to the RV or if the ramp door lock is jammed, the ZERO-G ramp door will need to be operated from inside the RV. To do so, the yellow strap between the 3-Seasons door and ramp door must be located and pulled. For quick guide instructions, please see next page.

⚠ WARNING

The ramp door may start to fall open once the actuation is initiated with the yellow pull strap. It is recommended to have someone capable of bracing the ramp door outside the coach to gently guide the ramp door to its desired position and avoid potentially damaging the door framing. Failure to do so may result in damage to your RV or personal injury.

SEC.23 RAMP DOOR & PATIO

INTERIOR GARAGE RAMP DOOR OPERATION:

1. Open the hinged door of the 3-Seasons door. It will only open a few inches, but that will be enough to pull the release strap.
2. Locate and grab the yellow strap hanging from the ZERO-G ramp jamb and pull down until you hear the latch release.



3. Once the latch releases, the door strikes will disengage and the door will slowly begin to open.
4. From the outside of the RV, guide the ramp door down to the desired position. Depending if the patio cables are connected, the ramp door may open to patio position or ramp position.
5. To close, ensure the garage entry door is fully open. This will allow pressure to be released as the ramp door closes.
6. Lift the ramp door back up into the closed position.
7. Push the ramp door firmly against the RV until a latching sound is heard.
8. Verify the door securely latched by pulling hard on the ramp door grab handle. If the door moves, open the door and repeat steps 4 through 6 until the ramp door properly closes.

3. Patio Position

When you would like to use the ramp door as a patio on the rear of the RV, the ramp door will need to be placed in the "patio position." This position is where the ramp door is parallel to the ground with the supplied support cables attached to the ramp door. To place your ramp door into this position, the below instructions should be followed.

PLACING THE RAMP INTO PATIO POSITION:

1. Open the garage door via the interior or exterior operation methods.
2. Locate and grab the patio cables that are connected to the gusset corners of the ramp door jamb. These are shown in the below photo (A).

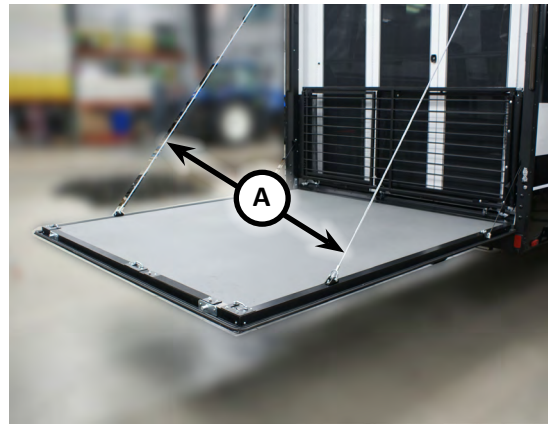

3. Once these cables have been located, gently guide the ramp door close to the parallel position to the ground.
4. The patio support cables can then be connected to the gussets circled in red below if they are not already attached. Generally, these are never disconnected.



⚠ WARNING

Cables must be connected to the gusset plates on the jamb and the ramp door to hold the ramp door in the patio position.

5. Locate the patio connection plates found on either side of the ramp door.



6. Place the cable eyelet between the plate verticals and insert the provided D-ring in the correct orientation and ensure it is secured with the supplied cotter pin. Please see below.



7. Repeat steps 4 through 6 on the opposing side.

⚠ WARNING

Only use the ramp door in patio position if the suspension cables are properly connected at both previously mentioned locations. Failure to do so could result in injury, damage to the ramp door, ramp door system, or the RV itself. The patio rail kit is not designed to support the weight of the ramp door, occupants, or other items placed on the ramp door. The support cables are designed to carry the weight.

4. Ramp Position

When loading your RV with ATV's, golf carts, bikes, or any other equipment, the ramp door will need to be placed in the "ramp position." This position allows one end of the door to make contact with the ground, while the other remains connected to the RV. This displacement of the door creates the "ramp."

If the ramp door is closed and the cables are connected for patio position, the below steps will need to be followed to convert the placement to ramp position.

PLACING THE RAMP INTO RAMP POSITION:

1. Open the garage door via the interior or exterior operation methods.
2. Locate the patio connection plates found on either side of the ramp door. The plates connect the patio cables to the RV and will need to be released to place the ramp door into ramp position.



3. After locating these plates, remove the D-ring pin holding the cable in place.



SEC.23 RAMP DOOR & PATIO

4. Repeat step 3 on the opposing side.
5. With both cables released, guide the ramp door down into ramp position. The ramp door is in ramp position when the leading or top edge of the ramp door engages the ground.

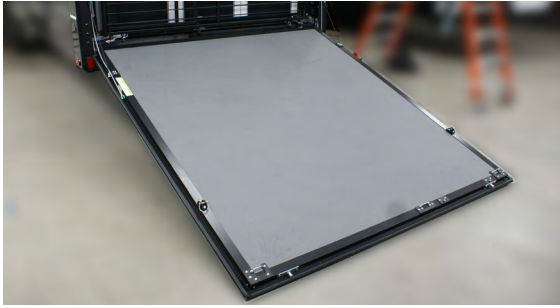

⚠ CAUTION

Make sure you hear the latching mechanism of the steps engage prior to moving on to the next step. If you are questioning if the locks are engaged, try to lift up and pull the steps away from the ramp to see if they will release. The steps should not move if they are seated and locked correctly.

- Once in the locked position, adjust the leg height of the steps so that the step treads are parallel to the ground. To do this, locate and remove the leg pin. This is shown in the photo below.

B. PATIO KIT

Your Brinkley RV is equipped with a full patio assembly including stairs, a patio rail kit and integrated gate, led lighting, an awning, and a 3-Seasons door.

To fully assemble your patio, the below instructions should be followed.

1. Setting-Up The Patio:

1. First begin by opening the ramp door into the patio position. See [Section 24A\(3\)](#).
2. Patio steps are not included with your unit. If you wish to purchase them aftermarket, contact Brinkley RV Customer Care Parts to order them.

To mount the steps to the patio:

- Press in the two push releases found on each side of the step rails and slide the rails over the connection posts located on the ramp door. As you release the push releases, you should hear the lock engage.



SEC.23 RAMP DOOR & PATIO

- The step treads will then need to be rotated in an upward and out motion to get them into position. Please see the photos below.



3. Now it is time to open and set up the rail kit. Carefully climb the steps onto the ramp door and locate the velcro (circled in red) on the patio rails and release the straps.



4. Starting with the first outermost section of the patio rail kit, carefully swing the rail towards the edge of the ramp door.



5. As the rail meets the edge of the ramp door, you will need extend the telescoping portion of the rail kit to the outermost corner of the ramp door. This is performed by pushing in the detent pin in the top rail (see A below for location) and then grabbing the rail and guiding it towards the direction of the stairs.



6. Once the rail is fully extended, engage the latching mechanism at the end of the railing as shown in the picture below.

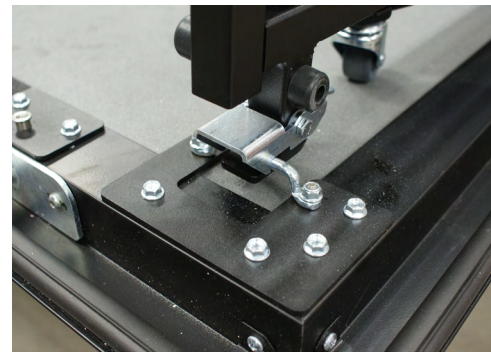

SEC.23 RAMP DOOR & PATIO

- Repeat steps 4 through 6 for the opposing rail. When complete, the rail should now be in the same position as what is displayed in the photo below.

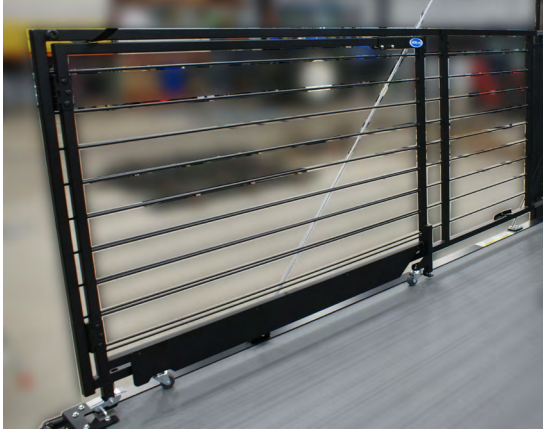

- The off door side rail also contains the rail kit portion for the front or top of the ramp door. Pivot the front rail into place and engage the latch as indicated in the below photo.



- For safety, take a moment to check each rail. It is important to make sure each foot latch is properly seated over its designated floor securement before the patio is used.

- Now that all rails are in place and secured via the foot latches, the gate can now be opened and closed. When the gate is in closed position, the gate latch should also remain in closed position. The latch is shown below.



⚠ WARNING

All components of the patio should be assembled in the manner in which the manufacturer describes. All moving parts should be verified that they are locked into place prior to using. Failure to follow these instructions may lead to damage to the RV, personal injury, or worse.

To stow the patio kit for transit, simply reverse the process of opening the rail kit.

C. 3-SEASONS DOOR

Your RV comes equipped with the Venture 3-Seasons Door. This door includes a three panel assembly, screens, and blackout shades. This door separates the garage area from the patio and rear exterior of the RV.

+ NOTICE

To fully operate the 3-Seasons door, the ramp door must be opened and the patio rails will either need to be in rail position or opened for loading.

+ NOTICE

The Three Season Door 3.0 is not waterproof. Ramp door must be closed during inclement weather.

1. Opening the Center Door

1. First begin by unlocking the interior latch by moving the locking lever (A) to the right.
2. Press the paddle (B) on the interior latch and push the center panel out to the open position.

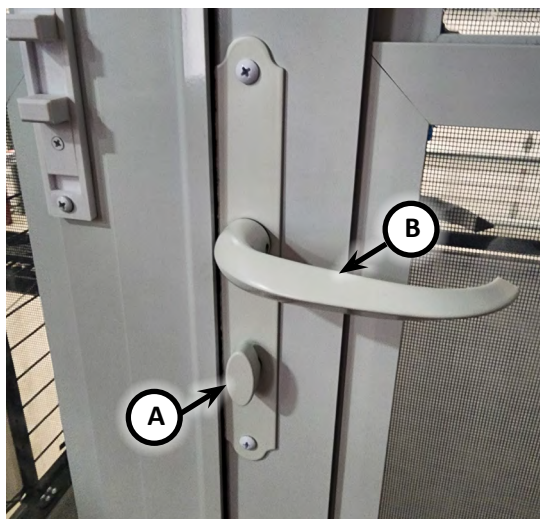

CLOSED POSITION



OPEN POSITION



SEC.23 RAMP DOOR & PATIO

2. Opening the Full Door

1. Open the center door until it contacts the outer door.
2. Release the upper and lower door stop plungers on each door by pinching the latch release buttons (A).

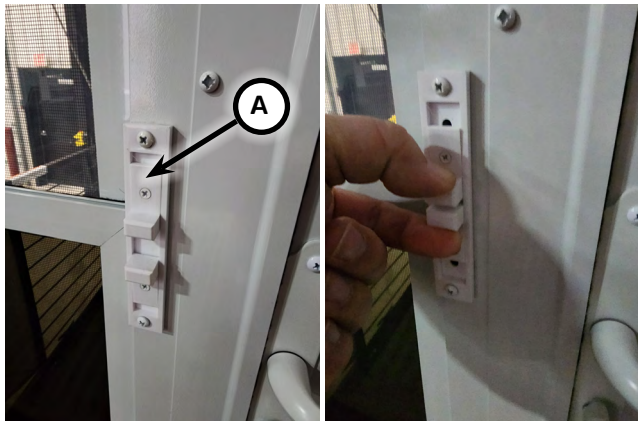

3. Open the doors outwards toward the ramp door. There are magnets on the 3 Seasons door panels that will hold the doors open against the top rail of the patio rail kit (B).



A. INTERIOR ACCESSORIES

Within your RV, there are many features and accessories to improve your experience. These features include a pull-out pantry and spice rack, hidden dog dishes, an extendable island, silverware drawer, and much more.

1. Pantry

The design of the pantry was guided by weight limitations and not based on the volume of items. Please bear this in mind as you load and stock the pantry. The pantry in the Model Gx is a simple cabinet with stationary shelves and pull out drawers.



This pantry can be used to store items you wish to take with you as you travel. The shelves within the cabinets were designed for common camping items such as paper plates, napkins, cookware, plastic cups, dry goods, etc. all of which are not heavy or bulky. Prior to traveling, it is best to make sure all loaded items are fully secure.

2. Silverware Drawer

Your RV is equipped with a hidden silverware drawer. This drop down silverware drawer is recessed in an overhead cabinet in the kitchen area. Circled in red, you will find the location of the silverware drawer in the G3500.



To operate, first turn the thumb latch (see below) to the open position, then grab the handle and gently pull in a downward motion. This will allow the drawer to pivot open.

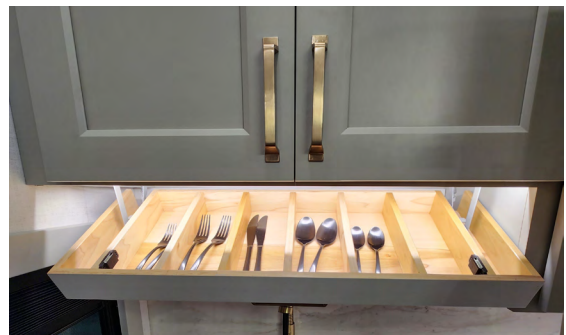

To close, simply push up on the handle until you feel the drawer seat into the closed position. Turn the thumb latch to the closed position to secure the drawer for travel. Prior to traveling with your RV, it is important to make sure this drawer is properly closed.



SEC.24 ACCESSORIES

3. Bathroom Storage

Your RV is equipped with storage cabinet within the bathroom. The upper storage has stationary shelves. The lower storage is an open shelf for a trash can. The cabinet is secured by magnetic latches to hold them closed during travel.



4. Recessed L-Track

Within the garage area of your RV, you will notice tracks in the floor. These tracks are known as L-tracks and are used to assist in securing your vehicles and equipment. L-track accessories can be moved along the track depending on the need.

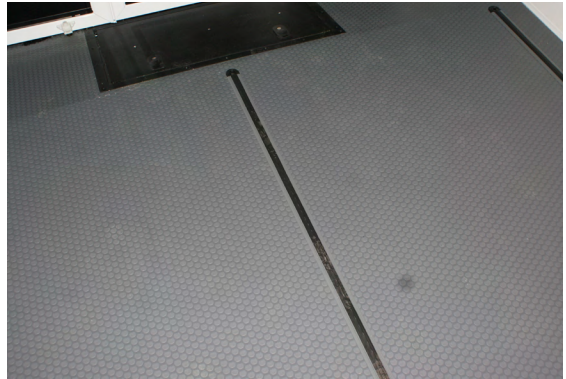

A. GENERAL

The exterior portion of the RV is composed of many materials including, but not limited to: Fiberglass, automotive paints, plastics, sealant, aluminum, and rubber.

The longer a foreign substance remains on the finish of the RV, the more likely it is to damage it. It is recommended that you keep the exterior of the RV cleaned and maintained on a continuous basis. This can be accomplished by frequently washing and waxing the RV with the recommendations outlined in the below sections.

The following materials may cause damage to the surface of the RV resulting in corrosion, staining, chemical spotting, and premature wear:

- Road dirt, dust, and debris Including, but not limited to, road salt, de-icing chemicals, tar, gravel, oils, and other automotive fluids.
- Tree sap, bird feces or droppings, and bugs.
- UV exposure, humidity, and moisture.
- Industrial fallout, hail, acidic rain, and other possible pollutants.

B. EXTERIOR CLEANING

Frequently washing the RV can help to protect it against environmental elements, such as acids, debris, and/or salts commonly found in air, water, and snow, and de-icing chemicals.

- Any time the RV encounters foreign materials, the RV should be washed.
- Try to avoid parking under trees, near saltwater bodies of water, or in direct sunlight.
- When ice or snow is present, never scrape the surface of the RV to remove, always brush snow and ice off with a soft bristle snow broom.
- If chemicals or solvents such as anti-freeze, gasoline, oil, etc. encounter the surface of the RV, rinse the affected area immediately.
- Bird and insect droppings should be rinsed off daily.

C. WASHING

- Never wash the RV in direct sunlight. Park in a shaded area and allow the RV surface to cool before washing.
- First spray the RV with water to remove loose dust and debris.
- Next, wash the RV.
 - Use a mild car wash detergent and water mixture.
 - Use a soft debris-free washing mitt or sponge.
 - Wash from the top down of the RV.
- Once fully washed, the RV should be thoroughly rinsed.
- Upon rinsing, immediately dry with a chamois or soft cloth.
- Joints, flanges, wiper seals, doors, etc. should be carefully hand cleaned to remove hidden or covered dirt and debris.
- NEVER use an automatic car wash on the RV.
 - Excessive heat may distort materials and cause resins to become damaged.
 - Excessive pressure may cause water to flood undesired areas within the RV.
- Avoid using high pressure water systems to clean the RV. This may force water into the RV.
- When using any form of pressure sprayer, extreme caution should be used near or around any door, attachment, window, vent, appliance, etc.
- Keep the tip of the sprayer roughly 16 inches or further away from the surface of the RV.
- If hazing or chalking occurs, wash, and wax a small trial area to see if luster returns.
- Have the RV inspected by your Dealer if the exterior becomes cracked or nicked.

SEC.25 RV EXTERIOR CARE

D. DURING COLD WEATHER

If the slide-out room, compartment door, or entry door becomes frozen shut, do not force it open. Doing so may result in damage to the seals, gaskets, and slide components. If seals become damaged, they will no longer be weatherproof.

To open:

- Apply warm water on the gasket or seal to melt the ice. Do not use boiled or hot water.
- Once the ice melts and the door or slide-out can be opened, thoroughly dry all water present.

+ NOTICE

Salt and other chemicals utilized on roads during winter months may cause damage to the RV and should be rinsed immediately. Rust may form if it is not cleaned from the metal surfaces and will be unwarrantable.

When exposed to salts and other chemicals during winter:

- Rinse the under portion of the RV (frame, axles, axle hangers, pinbox, LP lines, etc.) and all other parts of the RV that may have been exposed.
- After rinsing the RV, dry all water from all doors, slide-outs, and rubber seals or gaskets.

E. RV WAXING

The RV should be waxed once or twice a year, or when water no longer beads upon the surface of the RV. Take a soft cloth and apply a small amount of wax to the surface of the entire RV.

- Never wax in direct sunlight.
- If surfaces are warm, allow them to cool before beginning.
- Do not apply wax to weather stripping or rivets.
- If the wax stains the surface, remove with a warm water and a soft cloth.

- Once the wax is fully dry, hand buff the RV with a dry, soft cloth.
- Repeat this process until the desired results are obtained.

For additional information on graphic care, please see the manufacturer's PDF at <https://multimedia.3m.com/mws/media/9705400/qa-forconsumers-3m-wrap-film-series-1080-pdf>

+ NOTICE

DO NOT use a buffing compound or buffer on the surface of the RV as it may damage the exterior surface. If further assistance is needed, please contact your local RV body professional.

F. RV POLISHING

If the painted surfaces of the RV dull over time, are damaged, or lose their color, a mild polishing compound can be used. Polish a larger area than that of the damaged area to help to blend in the polished area. After the area has been treated with polish, thoroughly remove the polish from the surface and re-apply a coat of wax.

G. DAMAGED PAINT

After returning from a trip, all surfaces exposed to the road or near the tires should be inspected for paint damage that may have resulted from debris. If painted areas become damaged, they should be touched-up as soon as possible with touch-up film or paint. To purchase touch-up films or paints, please reach out to your closest automotive facility capable of matching paint. Please also refer to Section 25N pertaining to the RV frame/chassis.

H. PLASTIC COMPONENTS

To clean plastic components, use a soft cloth, sponge, or chamois with warm water. Refrain from using abrasive cleaning tools, soaps, or waxes as they may cause damage to the surface of the plastic components.

I. CHROME PARTS (IF EQUIPPED)

To prevent spotting or corrosion from occurring on chrome parts, always pat dry when exposed to moisture. When washed, rinse with water, thoroughly dry, and apply a non-abrasive wax for protection. If the chrome becomes severely damaged or pitted, chrome polishes can be utilized.

J. EXTERIOR ROOF

The Impact Guard roof membrane and vents on the roof should be inspected and cleaned twice a year with a mild soap and water solution.

- When cleaning the surface of the roof, refrain from using sharp tools (such as a putty knife) that could puncture or tear the membrane.
- All areas should be cleaned with a medium scrub brush.
- Once fully clean, rinse with water and allow the surface to air dry.
- If seals need to be reapplied, clean the area with a non-abrasive household cleaner first.
 - Always prep and re-seal an area **AFTER** the roof has already been washed.
 - Cleaners and solvents should **NOT** be used in the washing stage. Cleaners and solvents may damage existing seals or cause premature breakdown.

+ NOTICE

Never use petroleum distillates when washing the roof. This may cause irreversible damage.

⚠ WARNING

When on the roof, do so with great caution and navigate the area on your hands and knees. This will help to distribute your weight and reduce your risk of falling. As the water and mild soap solution are applied to the roof material, it can become very slippery.

K. SIDEWALL VENTS

There are various vents and appliance access panels that will need to be kept clean and clear of debris and obstructions. Holding tank vents will also need to be regularly inspected for possible obstructions caused by birds, insects, leaves, etc.

L. SEALANTS

There are many forms of sealants used on your RV including butyl tape, putty, encapsulated foam, silicone, roof sealant and Eternabond tapes. Each sealant has its own unique way to help protect your RV.

Although many seals do not have a set lifespan, due to environmental factors, deterioration may occur over time. If signs of deterioration are present, please replace the seal immediately to prevent possible damages.

Exterior sealants should be inspected every six (6) months and replaced as needed every year. Please contact your Dealer or Brinkley RV Customer Care for a copy of the Brinkley RV Seals Guide.

Dealer Expectation:

- Inspect ALL sealants every three (3) months the RV is on lot and replace as needed.
- Replace all seals once a year as required as preventative care.
- Resolve any water damage that occurred due to the lack of preventative care.

SEC.25 RV EXTERIOR CARE

If water is present inside the RV, immediately inspect the RV for leaks. If the origin of the leak cannot be determined and remedied, have your Dealer inspect the RV right away. Failure to properly maintain the RV or to correct a leak may result in extensive damage to the RV and is deemed unwarrantable.

Please contact your Dealer or Brinkley RV with any questions, or concerns that you have.

M. ROOF LADDER

There is a roof access, side mount ladder provided with the RV and is stored within the pullout storage found under the main pass-through storage on the off door side (driver's side). This will allow you to gain access to the roof. The roof contains decking under the rubber roof membrane that will allow you to walk on the roof to perform maintenance. This should be performed with caution.

WARNING

The installed ladder is capable of handling up to 300 lbs (136.08 kg). When in transit, no items should be attached to the ladder at any time.

N. RV FRAME/CHASSIS

Road debris, rocks, automotive fluids, sand, salts, and other road chemicals may cause damage to the frame's exterior paint. As its' protective coating becomes compromised, the frame becomes susceptible to rust and other forms of deterioration. Regularly inspect all exposed areas of the frame and repaint compromised areas after thoroughly cleaning.

O. WINDOWS

Condensation and heavy rains may allow water to accumulate within the window track. Regularly dry and clean this area to prevent mildew from forming.

The glass within the window can be cleaned using a glass cleaner and soft cloth or paper towel. After being cleaned, the glass should be dried with another soft, dry cloth.

1. Inspect the roof and all other surfaces for damage that may pose a threat for water to seep into the RV. Such leaks may go unnoticed until damage is already done.
2. Ensure all windows, roof vents, compartment doors, and entry doors are securely closed.

P. RAMP DOORS AND PATIO RAIL KITS

The exterior of the ramp door should be cleaned in the same manner as the exterior walls of the RV. The interior of the ramp door can be cleaned with soap and water and a soft bristle brush to help remove dirt and debris from the interior textured surface.

The Patio Rail Kit should also be kept clean and free from dirt and debris. Warm soap and water can be utilized. Towel dry after cleaning. Lubricate moving parts as needed.

Q. RV STORAGE PREPARATION

To help prevent problems from occurring, you should always prepare the RV before placing it in storage over extended periods of time. This preparation will not only protect your RV, but it will also make the process of removing the RV from storage much easier to accomplish.

1. Inspect the roof and all other surfaces for damage that may lead to water leaks or damage.
2. Ensure all windows, roof vents, compartment doors, and entry doors are securely closed.

3. Turn OFF the power to the refrigerator.
 - Once defrosted, the freezer and refrigerator should be cleaned.
 - Place baking soda and crumpled newspapers in the refrigerator to help eliminate odors.
 - Disconnect the ice-maker and drain the line.
4. Clean and empty the external mini refrigerator and place baking soda and crumpled paper inside the refrigerator to help eliminate odors.
5. Fully shut the propane cylinder valve(s).
6. Cover all external vents, exhausts, air conditioner, and outlets with mud dauber/rodent screens to prevent rodents from entering.

THESE MUST BE REMOVED PRIOR TO CONTINUING USE

7. Disconnect all external shore power.
8. Fully retract the leveling system and refrain from using while in storage.
9. Ensure all water tanks and water lines are drained.
10. Flush all holding tanks including the freshwater tank, gray tank, black tank, and the water heater.
11. Winterize the water system.

Please see plumbing winterizing instructions in Section 20P.

12. Use the main battery disconnect to disconnect all 12V power. Remove the battery from the RV and place on a battery maintainer for proper storage.

13. Thoroughly clean the inside of the RV removing any foods to prevent attracting rodents.
14. Wash the exterior surfaces of the RV.
15. If possible, store the RV indoor, under a roofed location, or under a breathable RV cover.
16. For UV and weather protection, cover the tires with tire covers.
17. Drain both fuel tanks and fuel lines.
18. Run stabilizer through the generator and change the oil.

+ NOTICE

Before winter months, ensure the RV's plumbing system is winterized. Failure to do so may result in frozen pipes and costly damages.

+ NOTICE

Damage caused or created by rodents or insects is unwarrantable. Please take proper measures to prevent infestation or entry.

R. SNOW REMOVAL

Throughout winter months, snow should be continuously removed from the top of your RV to help prevent possible damage from occurring.

+ NOTICE

Excessive snow and ice [8"+ (20.32 cm +) of snow or 2"+ (5.08 cm +) of ice] place additional stress and weight on the RV roof that should be removed immediately. This weight can be detrimental to the materials and structure of the RV. Continuously remove snow and ice as needed. Upon removing, do so with care to prevent damage to the roof, seals, vents, and appliances.

SEC.26 RV INTERIOR CARE

A. CLEANING THE INTERIOR

To increase the life of the RV, maintenance should be performed on a regular basis following the proper care procedures. In addition to this manual, please follow all instructions contained within the manufacturer's provided manuals.

+ NOTICE

Only cleaning products recommended within the manufacturer's manuals and this manual should be used on your RV. Using improper chemicals and cleaning agents may result in surface damage within the RV. Always test a small, inconspicuous area with the cleaning agent before using upon the entire surface. Contact your Dealer or Brinkley RV Customer Care for additional information and assistance.

⚠ WARNING

NEVER use flammable agents or sprays to clean your RV.

B. TABLES, CABINETS, AND DRAWERS

- Regularly dust all hardwood surfaces including cabinet doors and drawers, tables, and cabinet fronts using a soft cloth and cleaning polish or mild recommended solution.
- Do not use silicone oils or ammonia-based products on any surface. Prolonged use will result in damage to the surfaces.
- Clean accidental spills as they occur.
- Avoid prolonged exposure to direct sunlight, high humidity, extreme cold, or high temperatures. Extreme conditions may result in damage to finish and/or wood products.

C. WALL, CEILING, AND CABINET PANELING

- Use a solution of a mild soap and warm water.
- Always use a soft cloth or sponge.

- Refrain from using harsh cleaning agents as they may dull the surface color or cause micro-scratching. Always test cleaning agent in an inconspicuous area first.
- If a more aggressive cleaner is needed for stubborn dirt or grease, use an all-purpose cleaner.

D. COUNTERTOPS

The main countertops in the RV are made of porcelain. Special care must be exercised to prevent permanent damage to the countertop edges and surfaces as follows:

- **ALWAYS** use hot protective pads under any hot pans, dishes, or heat producing appliances.
- **NEVER** use a knife or sharp object directly on the countertops. **ALWAYS** utilize a cutting board.
- **NEVER** use harsh chemicals or cleaners (i.e., drain cleaners, oven cleaners, grease removers, etc.).
- **NEVER** mix bleach and other cleaning agents. Many commercial surface cleaners and cleaning solutions can be used to remove residue and dirt. Avoid the use of window cleaners as many glass solutions leave a waxy buildup that will dull the surface appearance. Utilize a damp microfiber cloth to clean the surface and dry with a dry microfiber cloth or towel to remove residual cleaner left behind. All countertops should be disinfected on a regular basis. This can be accomplished with disinfectant wipes or diluted household bleach (100:1, one hundred parts water to one part bleach).

E. VINYL FLOORING

Always test a small, inconspicuous area with the cleaning agent prior to using on the entire surface. If the surface dulls or pulls, discontinue use immediately to prevent further damage. Please see the cleaning guide on the next page for further instructions.

HOW TO TREAT STAINS, SPILLS & SCUFFS

Follow the remedies in order. Unless instructed otherwise, use a clean cloth or towel with the recommended liquids. Always rinse the affected area with clean water after treatment.

STAINS AND SPILLS

Acids, Alkalies	Dye, Dye Markings	Iodine	Vomit
Blood	Food, Candy	Mercurochrome	
Ketchup, Mustard	Fruit & Fruit Juices	Rust*	
Cleaners, Strong Soaps	Grass	Urine, Excrement	

REMEDY

- Scrub area with Congoleum Bright 'N Easy No-Rinse Cleaner at full strength.
- Rub area with a 10 to 1 dilution of water to liquid bleach.
- Rub area with isopropyl alcohol.**

**If rust stain does not respond, use lemon juice or a cream of tartar solution.*

PAINT AND SOLVENT SPILLS

Dry Cleaning Fluids	Lacquer	Latex Paints	Nail Polish
Oil-Based Paints	Solvents	Varnish	Wood Stains

REMEDY

1. If substance is dry, gently peel it from the floor (avoid sharp instruments that could scratch floor).
2. Scrub area with Congoleum Bright 'N Easy No-Rinse Cleaner.
3. Rub lightly with mineral spirits, isopropyl alcohol or lighter fluid.

SCUFFS & SMUDGES

Rubber Heel Marks	Scuffs
Shoe Polish	Smudges

REMEDY

There are several methods for removing scuffs on satin-gloss and matte floors. For matte-gloss floors, use recommended methods #1 and #3 only. For satin-gloss floors, all of the listed methods for removal are recommended, depending on the severity.

- Spray Fantastik® Cleaner on the scuff. Let stand for 10-15 seconds and then remove with a sponge or cloth.
- Using a damp sponge, rub scuffed area with a polishing cleaner such as Soft Scrub®. Rinse with a sponge or cloth.
- Wipe scuff with lighter fluid** applied with a clean cloth.
- With a rubbing motion, apply a car polish/cleaner such as No. 7® or similar product on the area, then rinse thoroughly.
- Remove stubborn scuffs with a mechanical buffer equipped with a lamb's wool pad.

***Caution: Isopropyl alcohol, lighter fluid, mineral spirits and paint thinner are flammable solvents. Carefully read and follow cautionary information on label. Keep traffic off treated area for 30 minutes.*

SEC.26 RV INTERIOR CARE

Sweep or vacuum regularly to remove dirt and grit that can abrade, dull, or scratch your floor. Do not use a vacuum with a beater brush, because it may damage the floor's surface. Wipe up spills promptly with a damp cloth or mop. For a more thorough cleaning, use a non-detergent based resilient floor cleaner or a mild soap and water mixture.

F. DINETTE TABLE, DINETTE CHAIRS

1. Portable Dinette Table

The dinette table is designed to seat up to four to six people. Prior to traveling, the dinette table must be broken down and secured back into its storage location. Securing the table will prevent damage from occurring while traveling. The dinette table is made of laminated wood and should only be cleaned using cleaners that are safe for MDF or vinyl products.

2. Bar Stools

There are two bar stools supplied with your RV. They are stored at the island in the main kitchen area. The bar stools are comprised of metal legs and a vinyl seat. The seat should only be cleaned with products suitable for vinyl cleaning. You should test the cleaner on an inconspicuous area first to ensure that the cleaner does not permanently damage the vinyl or change the color of the seat.

G. FURNITURE UPHOLSTERY

Furniture upholstery should be cleaned and maintained on a regular basis. This can be performed by wiping the surfaces with a soft damp cloth or by vacuuming with a soft bristle attachment. Please see the information outlined within this manual and also in the manufacturers' manuals.

1. Fabric

Brinkley RV is utilizing Richloom Tough Collection fabrics for the sofa, ottoman, and bedspread. For proper care and maintenance, please see the below instructions.

RICHLOOM TOUGH—PROPER CARE/ CLEANING GUIDELINES:

- Both PVC and Polyurethanes should be cleaned with a mild, water-based shampoo or soap.
- More stubborn stains can be cleaned with a mild, non-alcohol based, cleaning fluid.
- Rinse with clean water after.
- Once cleaned and rinsed, pat dry.

All fabrics are also treated with Fortress, a proprietary stain resistant. They recommend blotting any stains with a paper towel to remove excess spills. Then, prepare a mixture of ¼ cup (59.15 ml) mild detergent with 1 gallon (3.78 liters) of water. Spray the mixture on the area and blot again. Repeat until clean. Allow the area to air dry. For additional information and recommendations, please refer to the manufacture's manual.

2. Vinyl

When vinyl is stained, it should be professionally cleaned only as recommended.

CLEANING VINYL—LIQUID SPILL NO STAIN:

- Gently pat dry with paper towel or a soft cloth.
- Use a water-based cleaner.
- Always pat clean. Never rub or oversaturate the area.
- NEVER use solvents or harsh chemicals. Adverse reactions may occur to the backing of the vinyl if used.
- NEVER dry clean vinyl components. Adverse reactions may occur with use causing the backing of the vinyl to shrink and become brittle.

For additional information and recommendations, please refer to the manufacturer's manual.

+ NOTICE

Damage caused or created by rodents or insects is unwarrantable. Please take proper measures to prevent infestation or entry.

3. ABS Plastic

ABS plastic components will remain composed and only require to be dusted and cleaned on occasion. This can be accomplished with a soft, damp cloth (i.e., drain lines, plastic trims, plastic covers, vents, etc.).

- **NEVER** use abrasive soaps, compounds, or cleaning agents to clean ABS plastic components.
- **AVOID** the use of citrus, acidic, or D-Limonene containing solutions; such cleaners are capable of damaging the ABS plastic material.

I. DÉCOR

1. Glass Décor

Glass cleaner should be used to remove smudges, smears, and spots on the glass décor found within the RV. If there is decorative etching or frosting on the glass, be sure to clean with care in that given area.

2. Window Treatments

For the trim encompassing the windows, dust periodically with a soft cloth and a polish or mild solution. The trim is painted hardwood. Be sure that any cleaners utilized are compatible with painted wood product.

3. Blinds and Shades

Blinds and shades should be occasionally dusted using a vacuum and soft brush attachment or a soft cloth.

J. SHOWER WALLS

The shower walls within the RV should be cleaned with a mild solution of soap and warm water. NEVER use abrasive soaps, compounds, or cleaning agents to clean the shower walls.

K. SINK AND SHOWER FIXTURES

A mild soap and warm water mixture should be used to clean the sink and shower fixtures. If hard water spots are present, use a vinegar and warm water solution to clean.

L. STAINLESS STEEL SINK AND APPLIANCES (IF EQUIPPED)

When cleaning stainless steel products, please see the below instructions:

1. Use a soft cloth dampened by a solution of mild soap and warm water.
 - Never use abrasive soaps, compounds, cleaning agents, scouring pads, or steel wool.
 - Some glass cleaners or cleaners made for stainless steel can also be used. Always perform a trial cleaning when using new products.
2. Carefully wipe the surface, cleaning with the grain of the steel and not against it.
3. Thoroughly rinse the cloth and repeat this process until the appliance surface is clean.
4. Pat dry the surface with a paper towel or dry soft cloth.

SEC.27 MAINTENANCE

A. MAINTENANCE CHECKLIST

Below, you will find a quick reference checklist of all the suggested items that should be regularly inspected and maintained. Where listed, observe the mileage interval in place of the time interval. In addition to this provided checklist, please review the manufacturer’s manuals for additional information, instructions, warnings, and maintenance routines.

1. Prior to Your First Trip in Your RV

- **INSPECT** and reseal as needed.
- Ensure the propane system is properly inspected for leaks by your Dealer.
- Check tire pressure and torque on all wheel lug nuts. See Section 5J.
- Clean and sanitize the freshwater tank and system. See Section 200.
- **TEST** all safety alarms within the RV. See Sections 4E, 4F, and 4G.

- Refer to Section 4 for additional information and instructions.

2. Each Trip

- **INSPECT** the seals and re-seal as needed.
- Ensure the auxiliary battery is fully charged and healthy.
- Verify running lights operate.
- **CHECK** all tire pressures and wear. Don’t forget to check the spare. Tire pressure should be checked **BEFORE** the RV is traveled with, or while they are “cold.” See Section 5E.
- **CHECK** the torque of all wheel lug nuts. See Section 5J.
- **TEST** the braking system of the RV and the tow vehicle. See Section 7C.
- **TEST** all safety alarms and form a Family Safety Plan. See Section 4.

MAINTENANCE ITEM	EVERY TRIP	MONTHLY	EVERY 3 MONTHS	EVERY 6 MONTHS	ANNUALLY	BEFORE/AFTER STORAGE	PROCEDURE TO BE PERFORMED:
							MAINTENANCE SCHEDULES ARE MINIMUM REQUIREMENTS. EXTENDED USE, EXTREME TEMPERATURES, HIGH HUMIDITY OR OTHER EXTREME CONDITIONS WILL REQUIRE MORE FREQUENT MAINTENANCE.
APPLIANCES					X	X	CLEAN AND SANITIZE
		X				X	MAKE SURE BURNER TUBES/VENTS ARE CLEAN/UNOBSTRUCTED
					X	X	CHECK SETTINGS AND ADJUSTMENTS PER MANUFACTURER GUIDE
AWNINGS					X	X	CLEAN MOVING PARTS AND APPLY SILICONE OR TEFLON BASED DRY LUBE
						X	WASH WITH WARM WATER AND MILD DETERGENT
AXLES/ SUSPENSION	X			X		X	CLEAN MOVING PARTS AND APPLY SILICONE OR TEFLON BASED DRY LUBE
				X		X	WASH WITH WARM WATER AND MILD DETERGENT
BAGGAGE DOORS			X			X	SPRAY LOCK TUMBLERS WITH DRY GRAPHITE
		X				X	CONFIRM THAT DOORS SEAL TIGHT AND ARE NOT LEAKING
BRAKES/ WHEEL HUBS					X		CHECK AMP DRAW/SHOE WEAR/ADJUSTMENT (SEE MFG. SPECS)
					X		LUBE BEARINGS EVERY 12 MONTHS/12,000 MILES (AS REQUIRED)
					X		HAVE BRAKES AND HUBS INSPECTED BY A CERTIFIED RV SERVICE TECHNICIAN

BRINKLEY CUSTOMER CARE: phone: 888.502.3460 or 574.501.4280 / email: CustomerCare@BrinkleyRV.com

MAINTENANCE ITEM	EVERY TRIP	MONTHLY	EVERY 3 MONTHS	EVERY 6 MONTHS	ANNUALLY	BEFORE/AFTER STORAGE	PROCEDURE TO BE PERFORMED:
							MAINTENANCE SCHEDULES ARE MINIMUM REQUIREMENTS. EXTENDED USE, EXTREME TEMPERATURES, HIGH HUMIDITY OR OTHER EXTREME CONDITIONS WILL REQUIRE MORE FREQUENT MAINTENANCE.
ELECTRICAL SYSTEM			X		X	X	TEST ALL GFCI OUTLETS
					X	X	SERVICE GENERATOR (IF EQUIPPED) PER MANUFACTURER'S MANUAL
	X		X			X	CHECK AND SERVICE BATTERIES
ENTRY DOOR(S)			X			X	LUBE HINGES WITH SILICONE OR TEFLON BASED DRY LUBE
			X			X	ADJUST SCREEN DOOR AND LATCH
	X					X	CHECK DOOR LATCHES AND LOCKS FUNCTION PROPERLY
EMERGENCY EGRESS WINDOW(S)	X	X				X	OPEN AND CLOSE THE EMERGENCY EGRESS WINDOW(S) EVERY TRIP
ENTRY STEPS				X		X	CLEAN AND APPLY SILICONE OR TEFLON BASED DRY LUBE
EXTERIOR FIBERGLASS/METAL				X			APPLY NON-ABRASIVE WAX (EXCEPT ON DECALS)
			X				WASH WITH WARM WATER AND MILD DETERGENT
FRAME/ UNDERBELLY			X			X	CHECK FRAME FOR CHIPPED PAINT AND RUST, REPAINT AS NECESSARY
					X	X	CHECK FOR DAMAGE, LOOSE WIRES AND DEBRIS. CLEAN AS NECESSARY
HITCH/COUPLER					X	X	CHECK FOR DAMAGE AND WEAR. CLEAN AND LUBRICATE (WITH GREASE)
LP SYSTEM					X		HAVE SYSTEM TESTED FOR LEAKS BY A QUALIFIED DEALER
					X		PRESSURE
PLUMBING SYSTEM	X				X		DRAIN FRESH WATER HOLDING TANK AFTER EVERY TRIP. SANITIZE ANNUALLY (OR AS NEEDED).
	X						DRAIN AND FLUSH BLACK AND GRAY WATER HOLDING TANKS
					X	X	WINTERIZE SYSTEM BEFORE STORAGE (IN COLD CLIMATES)
			X		X	X	CHECK HOSES, FITTINGS, AND PIPES FOR LEAKS. TIGHTEN AS REQUIRED
ROOF AND ROOF ATTACHMENTS				X		X	CLEAN ROOF WITH WATER AND MILD DETERGENT
					X	X	CLEAN AND LUBE ROOF VENT MECHANISMS WITH LIGHT OIL

SEC.27 MAINTENANCE

MAINTENANCE ITEM	EVERY TRIP	MONTHLY	EVERY 3 MONTHS	EVERY 6 MONTHS	ANNUALLY	BEFORE/AFTER STORAGE	PROCEDURE TO BE PERFORMED: MAINTENANCE SCHEDULES ARE MINIMUM REQUIREMENTS. EXTENDED USE, EXTREME TEMPERATURES, HIGH HUMIDITY OR OTHER EXTREME CONDITIONS WILL REQUIRE MORE FREQUENT MAINTENANCE.
SAFETY EQUIPMENT				X			TEST AND CHECK FIRE EXTINGUISHER FOR PROPER CHARGE
	X	X				X	TEST AND CONFIRM EMERGENCY EGRESS WINDOW(S) FUNCTION PROPERLY
	X			X		X	CHECK OPERATION OF DETECTORS – RECHARGE AND REPLACE BATTERIES EVERY 6 MONTHS IF EQUIPPED
SLIDE ROOMS	X						CHECK SLIDE ROOF FOR DEBRIS – CLEAR AS NECESSARY
					X		SLIDE-OUT ROOM ADJUSTMENT PERFORMED BY A CERTIFIED RV SERVICE TECHNICIAN
	X		X			X	CHECK AND CLEAN ALL SEALS
WHEELS AND TIRES	X	X				X	CHECK TIRE INFLATION PRESSURE (SEE TIRE LABEL)
			X			X	INSPECT TIRES FOR WEAR/DAMAGE/ETC.
	X		X			X	CHECK WHEEL LUGS FOR PROPER TORQUE

A. AIR CONDITIONER (ROOF)

1. A/C Will Not Operate

WARNING

Working with any electrical system or appliance can be dangerous due to the risk of electrical shock. It is recommended that all inspections and repairs be performed by your Dealer or an authorized service location.

- Ensure there is proper power supplied via an external shore power.
- Make sure the A/C is ON.
- Inspect all fuses and breakers found within the power center.
- Follow any other troubleshooting suggestions provided within the manufacturer's manual. If the A/C is still inoperable, please contact your Dealer to inspect and repair as needed.

2. A/C Operates, but Coil Freezes and Compressor Cycles Prematurely

- Control setting may be set too low, causing compressor to cycle. Adjust as needed.
- Make sure there are no obstructions in the intake or exhaust.
- Clean the filter as needed.
- Inspect the intake baffle to ensure it is properly seated and not leaking or mixing with the output.
- Have your Dealer inspect coolant levels. If the A/C is still not operating correctly, please contact your Dealer to inspect and repair as needed.

3. A/C Does Not Effectively Get Cold

- Begin operation of the A/C at the beginning of the day before temperatures rise.
- Offset "heat gain" effectively by:

- Closing all windows and blinds.
- Keep entrance doors closed.
- Utilize the awning.
- Avoid the use of heat-producing appliances as much as possible.
- Ensure the outside coil is not obstructed or damaged.
- Ensure there is sufficient power to the RV.
- Have your Dealer verify the voltage at the A/C unit.
- If the A/C is still not operating correctly, please contact your Dealer to inspect and repair as needed.

B. ELECTRICAL POWER

1. No 12-Volt Power

- •Verify no fuses are blown at the 12-volt distribution panel.
- •Verify no fuses are blown at the 12-volt converter.
- Make sure that both battery disconnects are in the ON position.
- Make sure the battery is charged and healthy.
- Check the battery connections and terminals to ensure they are properly secured.
- If there is still no 12-volt power in the RV, please contact your Dealer to inspect and repair as needed.

2. No 120-Volt Power using Shore Power

- Make sure the breakers at the shore power pole are not tripped and make sure others in the area have power.

SEC.28 BASIC TROUBLESHOOTING

- Verify no breakers found within the power center have been tripped.
- Verify the GFCI is not tripped.
- Ensure your power cord is securely attached at the pole and to the RV.
- Have the park attendant verify that there is power at the shoreline receptacle.

If there is still no power within the RV, first contact the park maintenance team to ensure power is being properly supplied to the RV. If the problem persists please contact your Dealer to inspect and repair as needed.

3. No 120-Volt Power using Inverter Power

- First complete all steps found under No 12-volt Power.
- Verify no breakers found within the power center have been tripped.
- Ensure the inline inverter fuse is not blown
- Verify all molex connectors at the inverter are properly seated and proper connection is being made.
- Then complete all steps found under No 120-volt Power by Shore Power.

If there is still no power within the RV, please contact your Dealer to inspect and repair as needed.

4. No 120-Volt Power using Generator

- First follow all steps found in Section 28I.
- Ensure the breakers at the generator are not tripped.
- Verify no breakers found within the power center have been tripped.
- Verify the GFCI is not tripped.

If there is still no power within the RV, please contact your Dealer to inspect and repair as needed.

C. FURNACE

WARNING

If the furnace is not functioning, do not attempt to make repairs or adjustments. Turn off the thermostat and the LP supply at the cylinders. All inspections and repairs should be performed by your Dealer or an authorized service location.

1. No Ignition and/or Cycles Frequently

- Ensure there is sufficient propane within the cylinders.
- Remove possible obstructions in or on the furnace exhaust.
- Inspect the furnace fuse within the power center.
- Check that the return air is not obstructed. Items stored in front of the return should be relocated.
- Ensure all heat registers are open and unobstructed.
- Ensure that sufficient power is being supplied to the furnace.

If the furnace is still not functioning properly, please contact your Dealer to inspect and repair as needed.

D. INTERIOR LIGHTS

1. If Lights Flicker

- The converter may be over-heating.
- Reduce converter load by only operating appliances and lights that are needed.
- Open the compartment to allow for additional ventilation.
- Check the wire connections at the switch and at the light to ensure they are not loose.

If issue persists, please contact your Dealer to inspect and repair as needed

2. Lights Dim or are Half Bright

- Ensure sufficient power is being supplied
- Check for low battery voltage and recharge if needed.
- Check for loose connections.
- Loose connections can cause a weak or lost ground connection.
- Have the converter inspected by your Dealer.

If issue persists, please contact your Dealer to inspect and repair as needed.

E. MICROWAVE

1. Will Not Operate

- Make sure the door is properly closed.
- Reset the time and select START.
- Check for sufficient power supply.
- Inspect the breaker to make sure that it was not tripped.

If issue persists, please contact your Dealer to inspect and repair as needed.

F. MONITOR PANEL

1. No Lights at Panel When Switch is Pressed

- Ensure proper power is being supplied.
- Ensure the fuse behind the panel is not blown.
- Check the mini fuses and breakers in the front compartment.
- Have the panel tested by your Dealer.

If issue persists, please contact your Dealer to inspect and repair as needed.

2. Holding Tank Lights Give False Readings

- Verify the tank is empty.
- Clean any possible debris or build-up on the probe sensor.
- Clean and flush the tank by using a solution of two-parts vinegar mixed to one-part water. Repeat as needed.

If issue persists, please contact your Dealer to inspect and repair as needed.

G. OUTSIDE RECEPTACLE

1. No Power to Exterior Receptacles

- Make sure the RV is properly connected to external shore power.
- Check the breaker at the generator (Customer Supplied).
- Ensure the GFCI receptacle was not tripped.
- Check the breaker found within the power center.

If issue persists, please contact your Dealer to inspect and repair as needed.

H. OVEN

1. Oven Slow to Warm, Poor Baking, Poor Ignition of Burners, Pilots Won't Stay Lit, Top Burners Popping Sound, Carbon on Pilot Shield or Burner Flame Too Low or Too High

- Have your Dealer check the Pressure Regulator for the LP system. If issue persists, please contact your Dealer to inspect and repair as needed.

2. Top Burner or Oven Burner Won't Light or Won't Stay Lit

- Ensure top burners are properly set and aligned along with the flash tubing.
- With a toothpick, clean any possible clogged burner ports.
- Follow any other troubleshooting and maintenance suggestions provided within the manufacturer's manual.

If issue persists, please contact your Dealer to inspect and repair as needed.

3. Gas Smell

- Make sure the oven is not overloaded with food. Over-packing the oven leads to improper circulation which will cause a build-up of gas.
- Check connections using a leak detector solution (i.e., Dawn dish soap and water solution).

If issue persists, shut off the gas supply immediately, and contact your Dealer to inspect and repair as needed.

SEC.28 BASIC TROUBLESHOOTING

I. GENERATOR

1. Starter Engages When Holding Start Button, but Generator Does Not Start

- Ensure the generator has sufficient fuel. Generator is inoperable if the tank is under ¼ full.
- Check the oil level and correct as needed.

If issue persists, please contact your Dealer to inspect and repair as needed.

2. Start Button is Pushed, Nothing Happens

- Ensure battery disconnect is not engaged.
- Check 12-volt fuse on generator.
- Check the breaker found at the generator.

If issue persists, please contact your Dealer to inspect and repair as needed.

3. Starts, but Lacks Sufficient Power Supply

- Check the breaker at generator.
- Check the main breaker within the RV.

If issue persists, please contact your Dealer to inspect and repair as needed.

4. Clicking Sound When Attempting to Start

- Check battery voltage and recharge if needed.
- Check for poor ground or battery connection.

If issue persists, please contact your Dealer to inspect and repair as needed.

J. PROPANE GAS

1. Smell of Gas in or Around Unit

- Ensure propane cylinders are not overfilled.

If issue persists, please contact your Dealer to inspect and repair as needed.

⚠ WARNING

Working on the propane system, or with propane can be quite dangerous. Always have LP related repairs performed by your Dealer or a qualified service representative.

⚠ DANGER

IF YOU SMELL PROPANE:

1. Extinguish all open flames, pilot lights, smoking materials, etc.
2. Refrain from touching any electrical switches.
3. Shut off the propane supply at the LP bottles.
4. Ventilate the RV by opening all doors, windows, and vents.
5. Remain at a safe distance from the RV until all odor clears.
6. Have the propane system inspected and repaired as needed before continuing use.

Failure to comply with these instructions may result in explosion of the RV leading to serious injury or death.

K. REFRIGERATOR

1. Control Panel Lights Are Not Illuminating

- Ensure there is proper power being supplied to the RV.
- Check the battery voltage and recharge as needed.
- Check breaker found within the power center.

If issue persists, please contact your Dealer to inspect and repair as needed.

2. Not Properly Cooling

- Ensure there is sufficient power being supplied to the RV via external shore power.
- Make sure the refrigerator is level.
- Allow sufficient time for the refrigerator to cool. Loading chilled and frozen foods will help to cool the unit faster.

If issue persists, please contact your Dealer to inspect and repair as needed.

3. Frost Buildup on Evaporator Fins

- Allow the freezer and refrigerator to thaw.
- Refrain from overloading the provided area. Airflow and circulation are vital for proper cooling and to prevent frost buildup.

If issue persists, please contact your Dealer to inspect and repair as needed.

L. RUNNING LIGHTS

1. Running Lights Not Operating

- Check the fuse to ensure it is not blown.
- Check wiring connections.
- Replace the light as needed.

If issue persists, please contact your Dealer to inspect and repair as needed.

M. SLIDE-OUT

1. Runs In and Out Slowly, Binds, and/or Squeaks

- Ensure sufficient power is supplied.
- Lubricate slide-out rollers and gear pack (through frame slides only) with dry silicone spray lubricant.

If issue persists, discontinue the use of the slide-outs and contact your Dealer to inspect and repair as needed.

2. Water is Entering at the Rear Corners

- Verify that the exterior seals are making proper contact with the slide-out box. Seals may be flipped in the wrong direction.
- Ensure the seals are clean and free of any obstructions, dirt, or debris.
- Make sure the weep hole found in the slide pan is clean and unobstructed.

If issue persists, please contact your Dealer to inspect and repair as needed.

3. Room Will Not Move In or Out

- Ensure there is a sufficient power source.
- Verify battery voltage and recharge as needed.
- Check the auto-resetting mini-breaker located in the front fifth wheel bulkhead compartment. See the manufacturer's manual for additional information.

If the issue persists, please contact your Dealer to inspect and repair as needed.

N. TERMINATION VALVE

1. Leak at Termination Valve

- Ensure debris is not seated within valve.
- Replace valve as needed.

If the issue persists, please contact your Dealer to inspect and repair as needed.

O. TV ANTENNA

1. Poor TV Reception

- Check that the Antenna Power is ON.
Note that it is located in the ceiling behind the bedroom TV.
- Check the connections at both the TV and wall plate.

If the issue persists, please contact your Dealer to inspect and repair as needed.

P. WASTE TANK

1. Waste Tank Will Not Properly Drain

- Check for debris or buildup within the tank and clean as needed. To prevent buildup:
 - Use RV biodegradable toilet paper
 - Use plenty of water when flushing
- Check termination valve for possible obstructions.

If the issue persists, please contact your Dealer to inspect and repair as needed.

SEC.28 BASIC TROUBLESHOOTING

Q. WATER HEATER—TANKLESS

Follow any other troubleshooting and maintenance suggestions provided within the [manufacturer's manual](#).

R. WATER PUMP

1. Pump Inoperable

- Ensure there is sufficient power.
- Check pump switch and connection at the monitor panel.
- Inspect the fuse in power center to ensure it isn't blown.
- Verify the water is not frozen.

If the issue persists, please contact your Dealer to inspect and repair as needed.

2. Pump Will Not Prime

- Ensure there is sufficient water in the tank. This can be checked at the monitor panel.
- Verify there isn't trapped air in the hot water heater.
- Verify the water is not frozen.

If issue persists, please contact your Dealer to inspect and repair as needed.

3. Pump Runs Even When Water Is Off

- Ensure all water sources are turned off.
- Turn off the pump using the switch in the convenient center or the monitor panel.
- Check for water collections near or around plumbing appliances and fittings.
- Inspect toilet for leaking valves.

If issue persists, please contact your Dealer to inspect and repair as needed.

S. WATER SYSTEM

1. Wet Areas Near Water Connections, Pump Runs While the Faucets are Closed, and No Other Fresh Water Fixtures are Being Used

- Check for water leaks.
- Close all valves and low points to tanks and drains.
- Ensure all water fixtures are properly closed.
- Verify that all fixtures and connections are tight.

DO NOT over tighten fittings. This may damage seals and cause additional leakage.

3-SEASON DOOR

This refers to the patio door on a toy hauler.

7-WAY

A generic term for a hitch plug or connector. This plug connects the towing vehicle to the RV and supplies power to the turn signals, clearance lights, brakes, camera(s), and breakaway switch while the tow vehicle is in operation.

AC ELECTRICITY

Alternating current is an electric current which periodically reverses direction and changes its magnitude continuously with time in contrast to direct current which flows only in one direction. For purposes of this manual, it refers to 120-volt.

AMP

Short for ampere, the electrical current unit of measure. RV sites with electric hookup will specify the maximum amps supported, which generally come in units of 20, 30, or 50 amps. The RV power connector must match the various plugs of the site amp rating. Keep in mind that if using a reducer, your usage of items will be limited. If an outlet is not labeled, have it tested prior to plugging into it.

AUXILIARY BATTERY

An auxiliary battery allows you to power 12-volt DC devices anywhere, any time. This is a Customer/Dealer purchased, installed item.

AWNING

A canvas or other artificial material which extends from the RV body to provide shade. Awnings are generally placed on the entrance side of the RV. Not meant to be shelter or protection from storms.

BATTERY CONTROLLER

Maintains the life of the battery by preventing it from being overdrawn or overcharged.

BLACK WATER

Is human waste collected from the toilet. The black water can be emptied through a black water hose at a dedicated RV sewage dump.

BLUE BOY

Also known as a Honey Wagon, is a portable waste tank that allows you to dump your RV's sewage or gray water without taking your whole RV to the dumpsite.

BOONDOCKING

Is camping without hookups to electricity, water or sewage. Keep in mind that without alternate charge this is taxing on your auxiliary battery.

BREAKAWAY SWITCH

Is designed to bring a trailer to a safe stop by activating the electric brakes on the trailer, should the trailer be disconnected from the tow vehicle while driving. Do not pull this to test your brakes. You must have operational electric brakes on the unit, the 12-volt battery must be charged & the switch cable must be attached to the vehicle.

BRAKE CONTROLLER

Is an electronic device that activates and, as the word suggests, controls the electric brakes of a trailer. This device can be integrated or added to the tow vehicle. **NOT SUPPLIED WITH RV.**

BRITISH THERMAL UNIT (BTU)

Measurement of the heat content of fuels or energy sources. It is the quantity of heat required to raise the temperature of one pound of liquid water by 1° F (-17.2° C) at the temperature that water has its greatest density (approx. 39° F or 3.9° C).

CAMBER (WHEEL ALIGNMENT)

Is one of the angles made by the wheels of a vehicle; specifically, it is the angle between the vertical axis of a wheel and the vertical axis of the vehicle when viewed from the front or rear.

CAMPING

An outdoor activity involving overnight stays away from home, either without shelter or using basic shelter such as a tent or a recreational vehicle.

CARBON MONOXIDE

A colorless, odorless toxic flammable gas formed by incomplete combustion of carbon.

SEC.29 GLOSSARY

CARGO WEIGHT

The actual weight of all items added to the Curb Weight of the vehicle or trailer. Exceeding this weight could void certain warranties or cause damage to the RV.

CARGO CARRYING CAPACITY (CCC)

The Maximum permissible weight of personal belongings that can be added up. It is equal or less than Gross Vehicle Weight Rating minus Unloaded Vehicle Weight, full freshwater weight, and full LP (liquid propane) gas weight, and holding tank weights.

CITY WATER

This is a faucet at your campsite that allows you to connect your RV directly to a city water supply. No pump needed.

CONDENSATION

Is the water droplets that form on your RV walls, windows and make things feel wet. This can cause mold and mildew to form in your RV on walls, under the mattress, and more.

CONVERTER

An RV converter is responsible for converting standard 120-volt AC power into 12-volt DC power. The unit must be plugged in for this device to work.

CURB WEIGHT

The actual weight of a vehicle or trailer, including all standard equipment, full fuel tanks, full freshwater tanks, full propane bottles, and all other equipment fluids, but before taking on any persons or personal cargo.

CURBSIDE

This refers to the trailer side that faces the curb when parked. Also referred to as the door side, DS, or passenger side.

DC ELECTRICITY

Direct current is one-directional flow of electric charge. The auxiliary battery and converter both provide DC electricity. (Abbreviated 12 VDC).

DEALER

Means any person who sells or solicits or advertises the sale of new recreational vehicles.

DINETTE

Booth-like dining area. Table usually drops or is removable to convert into a bed at night.

DIRECT DUMP A/C

Air conditioning supplied directly from the vent on the A/C unit.

DISTRIBUTION PANEL

Refers to the power center that houses the breakers and distributes power to the RV.

DRY CAMPING

Camping when there is no city water hookup or shore power (i.e., using only the water and power available in the camper and not from any other source).

DRY WEIGHT

Is the weight of an RV as built at the factory. (UVW= Unloaded Vehicle Weight).

DSI (DIRECT SPARK IGNITION)

This term refers to the method of igniting the main burner on a propane fired appliance. The burner is lit with an electric spark and the flame is monitored by an electronic circuit board. This ignition system is used in refrigerators, furnaces, and water heaters. There is now a version of stove tops that light the burners with a DSI ignition.

DUAL ELECTRICAL SYSTEM

RV equipped with lights, appliances which operate on 12-volt battery power when self-contained, and with a converter, on 120VAC when in campgrounds or with an on-board generator.

DUALLY

Truck having two wheels on each side for a total of four wheels. This allow for more load capability.

DUCTED A/C

Air conditioning supplied through a ducting system in the ceiling. This supplies cooling air at various vents located throughout the RV.

DUCTED HEAT

Warm air from the furnace supplied to various locations in the RV through a ducting system located in the floor. (Similar to house heating systems).

DUMP STATION

Site where you drain your gray water (waste) and your black water (sewage) tanks. In most states, it is illegal to drain your tanks anywhere except dump stations.

DUMP VALVE

Another name for the T-handle valve used to release and drain the black tank (sewage) and gray tank (waste).

EGRESS WINDOW

Is essentially an emergency exit window in your RV that allows for the safe evacuation of occupants. (These windows are labeled).

E-TRACK

A recessed track that is designed to hold tie-down rings to assist in strapping down cargo.

FIFTH WHEEL (FW)

A trailer and hitch configuration connected to the tow truck directly above the rear axle by way of a special fifth wheel hitch. This causes several feet of the connected trailer to hang over the tow truck, placing about 15 to 25% of the trailer's weight on the rear axle of the truck. Commercial trucks and trailers use this hitch configuration. Also commonly spelled as 5th wheel.

FRESH WATER

The freshwater system provides potable water to the kitchen sink, shower, bathroom lavatory, toilet, water heater and outside shower.

FRESH WATER TANK

Tank for holding freshwater while not connected to a city water supply.

FULL HOOKUP SITE

A campsite that has city water, shore power and sewer hook-ups or connections available.

FULL-TIMERS or FULL-TIMING

The term used for people who live in their RV full-time, or at least the vast majority of their time.

GALLEY

The kitchen in an RV.

GARAGE

Refers to the back portion of the toy hauler where power sports tend to be stored.

GENERATOR

An engine powered device fueled by gasoline or diesel fuel, and sometimes propane, for generating 120-volt AC power.

GENSET

Abbreviation for built in generator.

GOOSENECK

A trailer and hitch configuration connected to the tow truck directly above the rear axle by way of a standard ball hitch in the truck bed and a vertical, slender arm on front of the trailer.

GRAY WATER

Term associated with the wastewater holding tank. Water from the sink drains, shower and washer/dryer go into this tank.

GROSS AXLE WEIGHT RATING (GAWR)

The MAXIMUM ALLOWABLE WEIGHT each axle assembly is designed to carry, as measured at the tires, therefore including the weight of the axle assembly itself. GAWR is established by considering the rating of each of its components (tires, wheels, springs, axle), and rating the axle on its weakest link. The GAWR assumes that the LOAD IS EQUAL ON EACH SIDE.

SEC.29 GLOSSARY

GROSS CARRYING CAPACITY (GCC)

Means the maximum carrying capacity of your camper. The GCC is equal to the GVWR minus UVW. The GCC will be reduced by the weight of fresh water or other tanks, propane, occupants, personal items or Dealer installed accessories. (Also referred to Cargo Carrying Capacity).

GROSS COMBINED WEIGHT RATING (GCWR)

The MAXIMUM ALLOWABLE COMBINED WEIGHT of the tow vehicle and attached towed vehicle. GCWR assumes that both vehicles have functioning brakes, with exceptions in some cases for very light towed vehicles, normally less than 1,500 pounds (680.4kg). (Check your tow vehicle's towing guide.)

GROSS TRAILER WEIGHT RATING (GTWR)

The MAXIMUM TOWED VEHICLE WEIGHT. Each component (receiver, drawbar, ball) of a ball-type hitch has its own rating. Some ball-type hitches have separate ratings when used with a weight distributing system.

GROSS VEHICLE WEIGHT RATING (GVWR)

The MAXIMUM ALLOWABLE WEIGHT of the fully loaded vehicle, including liquids, passengers, cargo, and the tongue weight of any towed vehicle.

HEAT EXCHANGER

A device that transfers heat from one source to another. For example, there is a heat exchanger in your furnace, the propane flame and combustion products are contained inside the heat exchanger that is sealed from the inside area.

Inside air is blown over the surface of the exchanger, where it is warmed and blown through the ducting system for room heating. The combustion gases are vented to the outside air.

HEAT STRIP

A heat strip is an electric heating element located in the air conditioning system with the warm air distributed by the air conditioner fan and ducting system. They are typically 1500-watt elements (about the same wattage as an electric hair dryer) and have limited function.

HEPVO VALVE

Is a unique self-sealing waste valve that prevents the escape of foul sewer air from waste discharge systems, and actively maintains the pressure equilibrium in soil and waste installations.

HIGH PROFILE

Is any vehicle that has a large, exposed surface area that cross winds can affect.

HITCH

The fastening unit that joins an RV to the tow vehicle.

HITCH WEIGHT

The amount of the camper's weight that rests on the tow vehicle. It should be approximately 12% - 15% with conventional travel trailers; approximately 18% - 21% for fifth wheels.

HOLDING TANKS

These are containers that store the fresh and wastewater in the RV. There are three types, freshwater, wastewater, and black water holding tanks.

HONEY WAGON

A truck or trailer that will travel to campsites, release the waste from your black and gray tanks and carry it off.

HOOKUPS

The ability of connecting to a campground's facilities. The major types of hookups are electrical, water and sewer. If all three of these hookups are available, it is termed full hookup. Hookups may also include telephone and cable TV in some campgrounds.

HOUSE BATTERY

One or more batteries in an RV for operating the 12-volt lights, appliances, and systems. House batteries can be 12-volt units tied in parallel or pairs of 6-volt batteries tied in series (to double the voltage). The term house battery is of more

significance in motor homes because they contain one or more other batteries for the operation of the engine, referred to as the chassis or starting batteries.

INVERTER

An inverter is a device that changes 12-volt battery power to 120-volt AC power. It is used when “boon docking” (camping without hookups) to power certain 120 VAC only devices like a microwave oven. The amount of available power depends on the storage capacity of the batteries and the wattage rating of the inverter.

ISLAND QUEEN or ISLAND KING

A king or queen-sized bed with walking space on both sides.

JACKKNIFE

The 90° angle obtained from turning/backing fifth wheel or travel trailer with tow vehicle. Jackknifing a short bed truck towing a fifth wheel without the use of a slider hitch or extended fifth wheel pin box can result in damage to the truck cab or breaking out the back window of the truck cab from the truck and fifth wheel “colliding.”

KINGPIN

The pin by which a fifth wheel trailer attaches to the truck. It slides into the fifth wheel hitch and locks in place.

KINGPIN WEIGHT

The actual weight pressing down on the fifth wheel hitch by the trailer. The recommended amount of Kingpin Weight is 15%-25% of the GTW, also called Pin Weight.

LAMINATE

A sandwich of structural frame members, wall paneling, insulation and exterior covering, adhesive-bonded under pressure and/or heat to form the RV’s walls, floor and/or roof.

LANDING GEARS

See Leveling Jack.

LEVELING

Positioning the RV in camp so it will be level, using ramps (also called levelers) placed under the wheels, built-in scissors jacks, or leveling jacks.

LEVELING JACK

A jack lowered from the underside of trailers and motor homes for the purpose of leveling the vehicle. A leveling jack is designed to bear a significant portion of the RV’s weight.

LP GAS

Liquefied Petroleum Gas, commonly written as “LP Gas.” Two examples of LP Gas are propane and butane. LP Gas is heavier than air in gas form and about half the weight of water in liquid form. LP gas is used to fuel appliances in the RV, such as the stove, oven, water heater and refrigerator. Propane tanks are usually rated as pounds or gallons.

LOW POINT

The lowest point in the plumbing. Drains are placed here so that water will drain out of the lower end of the camper when flushing or winterizing the water system. These drains must be closed when you fill the water tank.

MONITOR PANEL/CONVENIENCE CENTER

The panel in which the tank monitor is located and the panel that has the common RV function switches.

MOTORHOME (MH)

A motor vehicle built on a truck or bus chassis and designed to serve as self-contained living quarters for recreational travel.

NET CARRYING CAPACITY (NCC)

The MAXIMUM WEIGHT of all personal belongings, food, fresh water, propane, tools, Dealer installed accessories, etc., that can be carried by the RV.

NON-POTABLE WATER

Water NOT suitable for human consumption.

SEC.29 GLOSSARY

OEM

This refers to the original equipment manufacturer of the individual appliances or components.

PATIO MAT

Carpet or woven mat for use on ground outside of RV. Used whether or not a concrete patio pad is available where camping.

PAYLOAD CAPACITY

The maximum allowable weight that can be placed in or on a vehicle, including cargo, passengers, fluids and fifth-wheel or conventional hitch loads.

PILOT

A pilot is a small standby flame that is used to light the main burner of a propane fired appliance when the thermostat calls for heat. Pilots can be used in furnaces, water heaters, refrigerators, ovens, and stove tops.

PIN BOX

Is the hitch of the fifth wheel that connects the RV to the tow vehicle.

PORPOISING

A term used to define the up and down motion in an RV while traveling. Also commonly referred to as “chucking.”

POWER SOURCE

Also referred to as shore power, this refers to the receptacle outlet you are using to plug in your shoreline power cord. This can be a campsite power box or electrical box, a residential receptacle outlet specifically wired for your camper or a generator (Customer Supplied).

PRIMITIVE SITE

A campsite that may have city water, shore power or sewer hook-ups but not all of them; primitive sites may have no hook-ups or connections at all.

PROPANE

LPG, or liquefied petroleum gas, used in RV's for heating, cooking and refrigeration. Also called

bottle gas, for manner in which it is sold and stored. This is the proper term in the RV industry when referring to “LP Gas.”

PULL-THROUGH SITES

Campsites you can drive through and park (without having to back up into the site).

REFER

Slang for “Refrigerator.”

RIG

What many RV'ers call their units.

ROADSIDE

The trailer side that faces the road when parked. Also called streetside, off door side or ODS.

ROOF AIR CONDITIONING

Air conditioning unit mounted on roof of RV, to cool the RV when it is parked.

RV

Short for Recreation Vehicle, a generic term for all pleasure vehicles which contain living accommodations. Multiple units are RV's and persons using them are RV'ers.

RVDA

Recreational Vehicle Dealer's Association.

RVIA

Recreational Vehicle Industry Association.

SELF CONTAINED

RV which needs no external electrical, drain or water hookup. Thus, it can park overnight anywhere. Of course, self-contained units can also hook up to facilities when at campgrounds.

SANITIZED

Refers to the camper's freshwater system that has been sanitized before use or after storage.

SHORE POWER

120-volt AC power that is supplied by an external source such as a campground or house set-up.

SHORELINE POWER CORD

This is the electrical power cord that runs from the camper to the campsite shore power outlet.

SLEEPING CAPACITY WEIGHT RATING (SCWR)

The manufacturer's designated number of sleeping positions multiplied by 154 pounds (70 kilograms).

SLIDE-OUT

A compartment added to an RV to increase interior space. It slides into the body during travel and slides out when parked.

SNOWBIRD

Term for someone in a northern climate that heads "south" in winter months.

STINKY SLINKY

Slang for the sewer hose, constructed from a spiral wire covered with vinyl. One end attaches to the RV piping and the other into the local sewer dump facilities.

STREETSIDE

The trailer side that faces the street when parked. Also called the roadside, off door side or ODS.

SURGE PROTECTOR

Device (Customer Supplied) that is installed at the power supply location designed to prevent "surges" or "spikes" in electrical current that may damage the RV's electrical/electronic components.

SWAY

Fishtailing action of the trailer caused by external forces that set the trailer's mass into a lateral (side-to-side) motion. The trailer's wheels serve as the axis or pivot point. Also known as "yaw."

THERMOCOUPLE

A thermocouple is a device that monitors the pilot flame of a pilot model propane appliance. If the pilot flame is extinguished the thermocouple causes the gas valve to shut off the flow of gas to both the pilot flame and the main burner.

TIE-DOWN RING

Anchor that can be inserted in the E-Track to assist in securing cargo.

TIP OUT

The term used for an area or room in an RV that tips out for additional living space. The Tip-Out was generally used in older RV's. Newer RV's mainly use a slide-out.

TIRE RATINGS

The MAXIMUM LOAD that a tire may carry is engraved on the sidewall, along with a corresponding COLD inflation pressure. A reduction in inflation pressure requires a reduction in load rating. Tire manufacturers publish charts that establish the load capacity at various inflation pressures.

TOE (WHEEL ALIGNMENT)

Toe is the measure of whether the front of the wheels (looking down from the top) are closer (toe-in) or farther (toe-out) than the back of the wheels.

TONGUE WEIGHT, TONGUE LOAD, VERTICAL LOAD (TWR/TLR/VLR)

Tongue Weight, Tongue Load, Vertical Load Rating Different terms for the MAXIMUM VERTICAL LOAD that can be carried by the hitch UNLOADED.

TRAILER BRAKES

Brakes that are built into the trailer axle systems and are activated either by electric impulse or by a surge mechanism. The overwhelming majority of RV's utilize electric trailer brakes that are actuated when the tow vehicle's brakes are operated, or when a brake controller is manually activated. Surge brakes utilize a mechanism that is positioned at the coupler, that detects when the tow vehicle is slowing or stopping and activates the trailer brakes via a hydraulic system (typically used on boats).

TRAVEL TRAILER (TT)

Also referred to as "conventional trailers," these types of rigs have an A-frame and coupler and are attached to a ball mount on the tow vehicle. Travel trailers are available with one, two or three

SEC.29 GLOSSARY

axles. Depending upon tow ratings, conventional trailers can be towed by trucks, cars or sport-utility vehicles.

UNDERBELLY

The RV's under-floor surface, which is protected by a weatherproofed material.

UTQGL (UNIFORM TIRE QUALITY GRADE LABELING)

A program that is directed by the government to provide consumers with information about three characteristics of the tire: tread wear, traction, and temperature. Following government prescribed test procedures, tire manufacturers perform their own evaluations for these characteristics. Each manufacturer then labels the tire, according to grade.

UV DEGRADATION

A breaking down of material due to the sun's harsh ultraviolet rays.

UNLOADED VEHICLE WEIGHT (UVW)

The WEIGHT of a vehicle as built at the factor with full fuel, engine (generator) oil and coolants. It does not include cargo, fresh water, propane, occupants, or Dealer installed accessories.

WASTEWATER TANKS

The gray water tank holds the wastewater from the sinks and showers. The black water tank holds the waste from the toilet.

WATER PRESSURE REGULATOR

Device (Customer Supplied) installed on the water hose attached to city water to limit the water pressure entering the RV. Most regulators limit water pressure to 40 psi (275.8 kPa).

WEIGHT AND LOAD

These terms are generally used interchangeably. For the purposes of understanding RV applications:

- Vehicles have WEIGHT, which impart LOADS to tires, axles and hitches.

- Scale measurements taken when weighing, are LOADS carried by the tires. The measured LOADS are used to calculate Gross Combination Weight (GCW) Gross Vehicle Weight (GVW), Gross Axle Weight (GAW), and Hitch Loads.

WET WEIGHT

The weight of the vehicle with the fuel, freshwater and propane tanks full.

Note these important weights:

Propane	4.25 lbs. per gallon (0.51 kg/liter)
Water	8.3 lbs. per gallon (0.995 kg/liter)
Gasoline	6.3 lbs. per gallon (0.755 kg/liter)
Diesel fuel	6.6 lbs. per gallon (0.79 kg/liter)

WHEEL CHOCKS

Any solid material such as rubber, dense plastic, wood, etc. that can be placed in front or behind the tire to prevent the RV from rolling when in a parked position.

WIDE BODY

An RV having an external body width greater than 96 inches (2.44 m). The most common wide-body widths are 100" (2.54 m) and 101" (2.654 m).

WINTERIZED

Refers to a camper that has been prepared for storage. The water systems have been drained and RV antifreeze has been added to protect the water lines and drains. The low point drains should be in the open position.

YAW

Fishtailing action of the trailer caused by external forces that set the trailer's mass into a lateral side-to-side motion. The trailer's wheels serve as the axis or pivot point. Also known as "sway."

